

FIT SYSTEM

Solutions de bureaux acoustiques modulaires recouvertes de textile

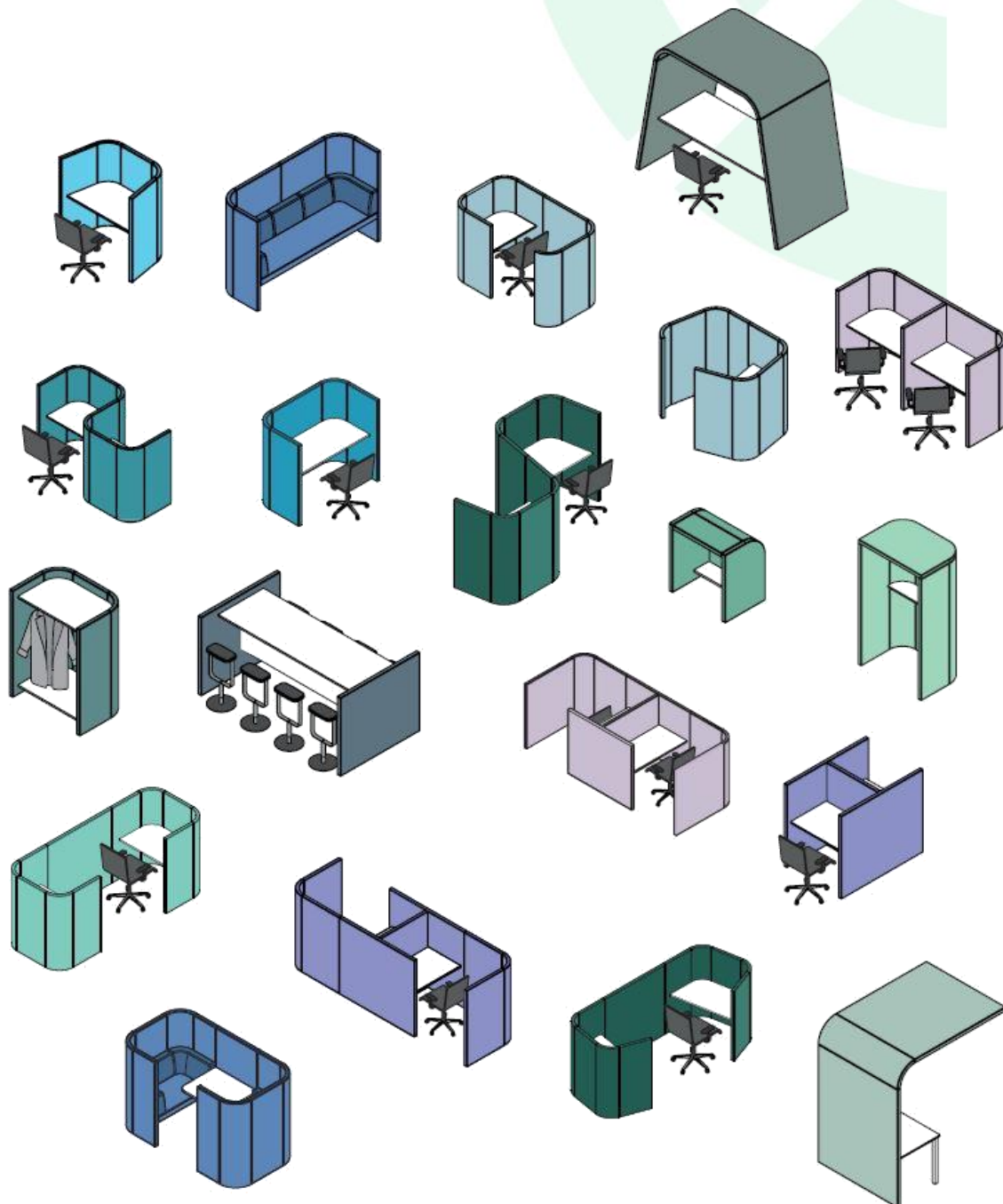

LE SYSTÈME FIT

Les panneaux du système FIT sont des éléments modulables fins et élégants dotés d'un système de fixation invisible et très pratique. Ce sont des monolithes simples et combinables, dont les solides structures en aluminium et bois sont entièrement recouvertes du tissu. Ils constituent la collection idéale pour composer toutes les situations d'espace de travail (cloisons, bureaux, salles de réunion et zones de repos,...) et créer un environnement harmonieux et avec une très haute performance acoustique. La collection intègre par ailleurs les FIT sofas, flexibles et confortables, conçus par le designer Alain Berteau.



INFORMATION TECHNIQUE

Éléments de partition et de mobilier. Structure interne en composé de profils d'aluminium extrudé et de panneaux de particules de bois. Les structures des faces latérales sont dotés d'inserts permettant les connexions latérales des modules entre eux, par des tiges usinées et serties. La structure de base est équipée d'inserts cylindrique M8 avec patins de réglages ajustables. Les éléments FIT sont remplis de panneaux de mousses acoustiques.

Usage :	Intérieur
Épaisseur :	62mm
Connexions :	2 tiges usinées et serties assemblent les éléments mécaniquement.
Configurations :	Selon les versions, connexion des éléments à 180°, 90°, en «L», «T» ou en croix.
Garantie :	2 ans sur les défauts de production, en usage normal d'environnement de bureau.
Durabilité :	5 ans
Poids :	Selon les versions, consulter la liste des références.
Emballage :	Carton multicouche avec renforts et bâche plastique thermo-rétractable.
Eco-contribution:	Famille bois et métal.
Absorption :	$\alpha_w = 1.00$

COEFFICIENT D'ABSORPTION

Certifié Classe « A » selon les normes ISO 354 et ISO 11654

F(Hz)	100	125	250	500	1000	2000	2500	4000	5000
Coefficient d' absorption (α_s)	0,14	0,20	0,68	0,98	1,07	1,13	1,10	1,15	1,18

CONFIGURATIONS



FIT U WORKSTATION 90°



FIT S WORKSTATION 90°



FIT C WORKSTATION 90°



FIT DOUBLE U WORKSTATION



FIT PENTAGONE



FIT E WORKSTATION



FIT SOFA



FIT CELL



FIT BAR



FIT U WORKSTATION 100°



FIT S WORKSTATION 100°



FIT C WORKSTATION 100°



FIT H WORKSTATION



FIT H WORKSTATION + FIT WALLS



FIT H WORKSTATION + FIT WALLS



FIT BRIDGE



FIT WALL BRIDGE



FIT U WARDROBE





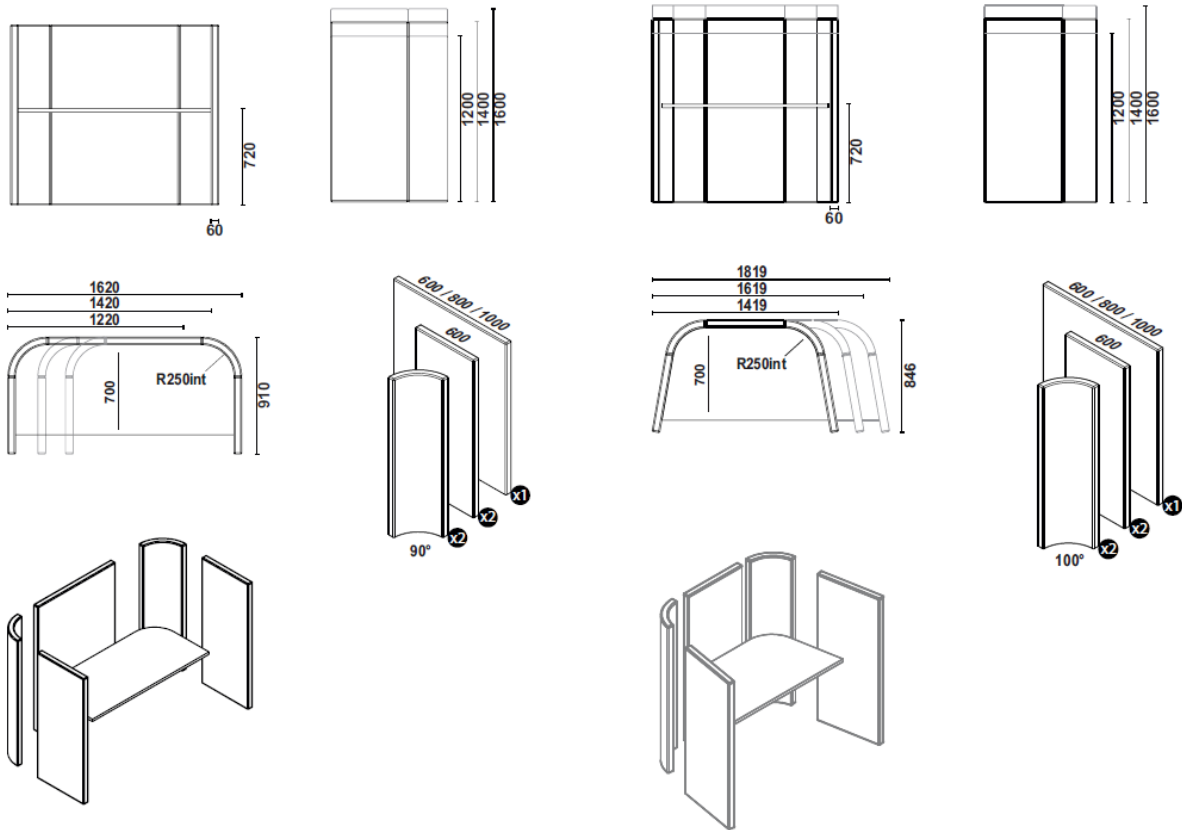

FIT HOOD

FIT U WORKSTATION 90° & 100°







FIT U WORKSTATION 90°

-  **Cat 1**
Camira Cara
Camira Carlow
Camira Urban
Camira Xtreme
Fidivi King Flex
-  **Cat 2**
Camira Main Line Flax
Camira Main Line Plus
Camira Xtreme CS (M1)
-  **Cat 3**
Camira Blazer
Camira Blazer Lite
Camira Synergy
-  **Cat 4**
Kvadrat Gabriel Step
Kvadrat Revive 1/2
Kvadrat San
Kvadrat Remix 2
Kvadrat Steelcutrio
Kvadrat Canvas
Kvadrat Divinamelange 2



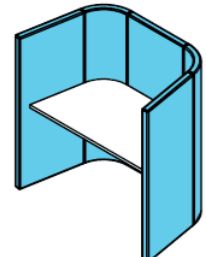

FIT U WORKSTATION 100°

-  **Cat 1**
Camira Cara
Camira Carlow
Camira Urban
Camira Xtreme
Fidivi King Flex
-  **Cat 2**
Camira Main Line Flax
Camira Main Line Plus
Camira Xtreme CS (M1)
-  **Cat 3**
Camira Blazer
Camira Blazer Lite
Camira Synergy
-  **Cat 4**
Kvadrat Gabriel Step
Kvadrat Revive 1/2
Kvadrat San
Kvadrat Remix 2
Kvadrat Steelcutrio
Kvadrat Canvas
Kvadrat Divinamelange 2



FIT U WORKSTATION 90°
FIT U WORKSTATION 100°

 1200-1400-1600 mm
1200-1400-1600 mm

 1220-1420-1620 mm
1419-1619-1819 mm



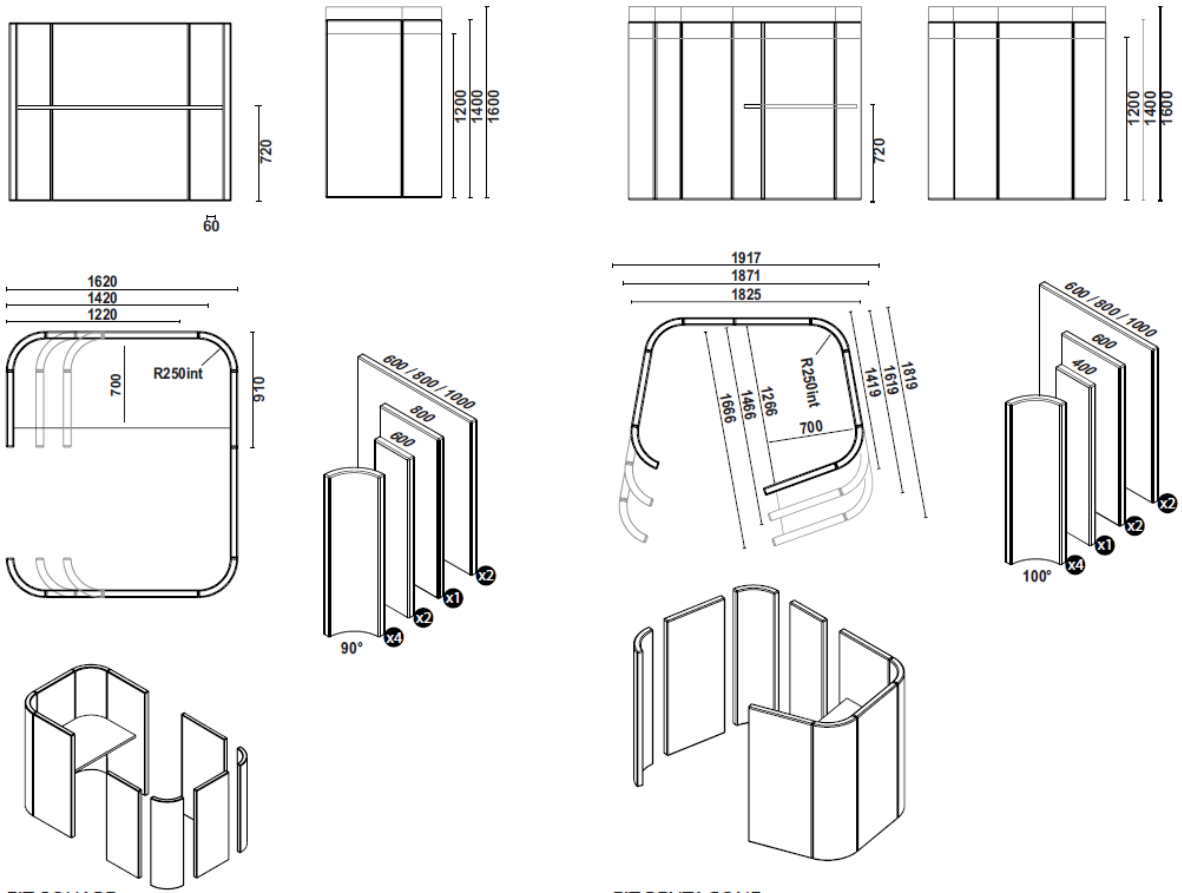

 50 > 61
50 > 61

 7 weeks
7 weeks

FIT SQUARE & PENTAGONE





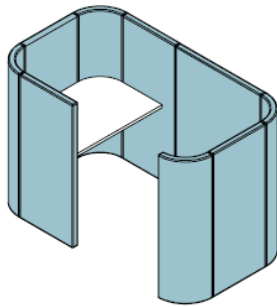

FIT SQUARE

-  **Cat 1**
Camira Cara
Camira Carlow
Camira Urban
Camira Xtreme
Fidivi King Flex
-  **Cat 2**
Camira Main Line Flax
Camira Main Line Plus
Camira Xtreme CS (M1)
-  **Cat 3**
Camira Blazer
Camira Blazer Lite
Camira Synergy
-  **Cat 4**
Kvadrat Gabriel Step
Kvadrat Revive 1/2
Kvadrat San
Kvadrat Remix 2
Kvadrat Steelcutrio
Kvadrat Canvas
Kvadrat Divinamelange 2



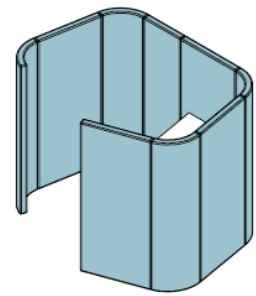

FIT PENTAGONE

-  **Cat 1**
Camira Cara
Camira Carlow
Camira Urban
Camira Xtreme
Fidivi King Flex
-  **Cat 2**
Camira Main Line Flax
Camira Main Line Plus
Camira Xtreme CS (M1)
-  **Cat 3**
Camira Blazer
Camira Blazer Lite
Camira Synergy
-  **Cat 4**
Kvadrat Gabriel Step
Kvadrat Revive 1/2
Kvadrat San
Kvadrat Remix 2
Kvadrat Steelcutrio
Kvadrat Canvas
Kvadrat Divinamelange 2



FIT SQUARE
FIT PENTAGONE

 1200-1400-1600 mm
1200-1400-1600 mm

 1419-1619-1819 mm
1419-1619-1819 mm

 70 > 83
70 > 83

 7 weeks
7 weeks

FIT S WORKSTATION 90° & 100°

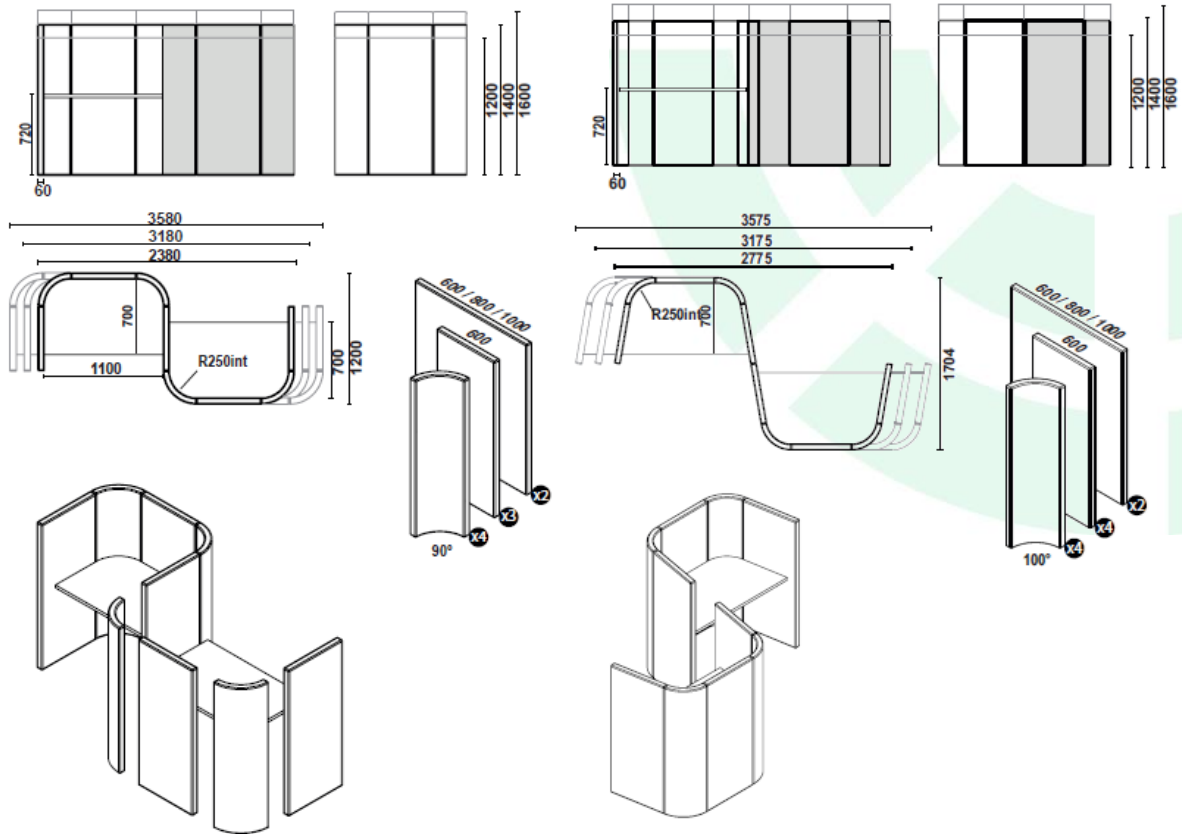

FIT S WORKSTATION 90°

-  **Cat 1**
Camira Cara
Camira Carlow
Camira Urban
Camira Xtreme
Fidivi King Flex

-  **Cat 2**
Camira Main Line Flax
Camira Main Line Plus
Camira Xtreme CS (M1)

-  **Cat 3**
Camira Blazer
Camira Blazer Lite
Camira Synergy

-  **Cat 4**
Kvadrat Gabriel Step
Kvadrat Revive 1/2
Kvadrat San
Kvadrat Remix 2
Kvadrat Steelcutrio
Kvadrat Canvas
Kvadrat Divinamelange 2



FIT S WORKSTATION 100°

-  **Cat 1**
Camira Cara
Camira Carlow
Camira Urban
Camira Xtreme
Fidivi King Flex

-  **Cat 2**
Camira Main Line Flax
Camira Main Line Plus
Camira Xtreme CS (M1)

-  **Cat 3**
Camira Blazer
Camira Blazer Lite
Camira Synergy

-  **Cat 4**
Kvadrat Gabriel Step
Kvadrat Revive 1/2
Kvadrat San
Kvadrat Remix 2
Kvadrat Steelcutrio
Kvadrat Canvas
Kvadrat Divinamelange 2

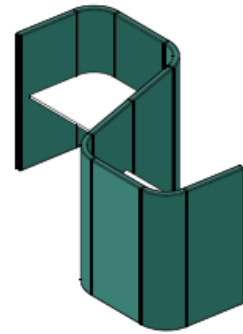

FIT S WORKSTATION 90°
FIT S WORKSTATION 100°

1200-1400-1600 mm
1200-1400-1600 mm

2380-3180-3580 mm
1419-1619-1819 mm



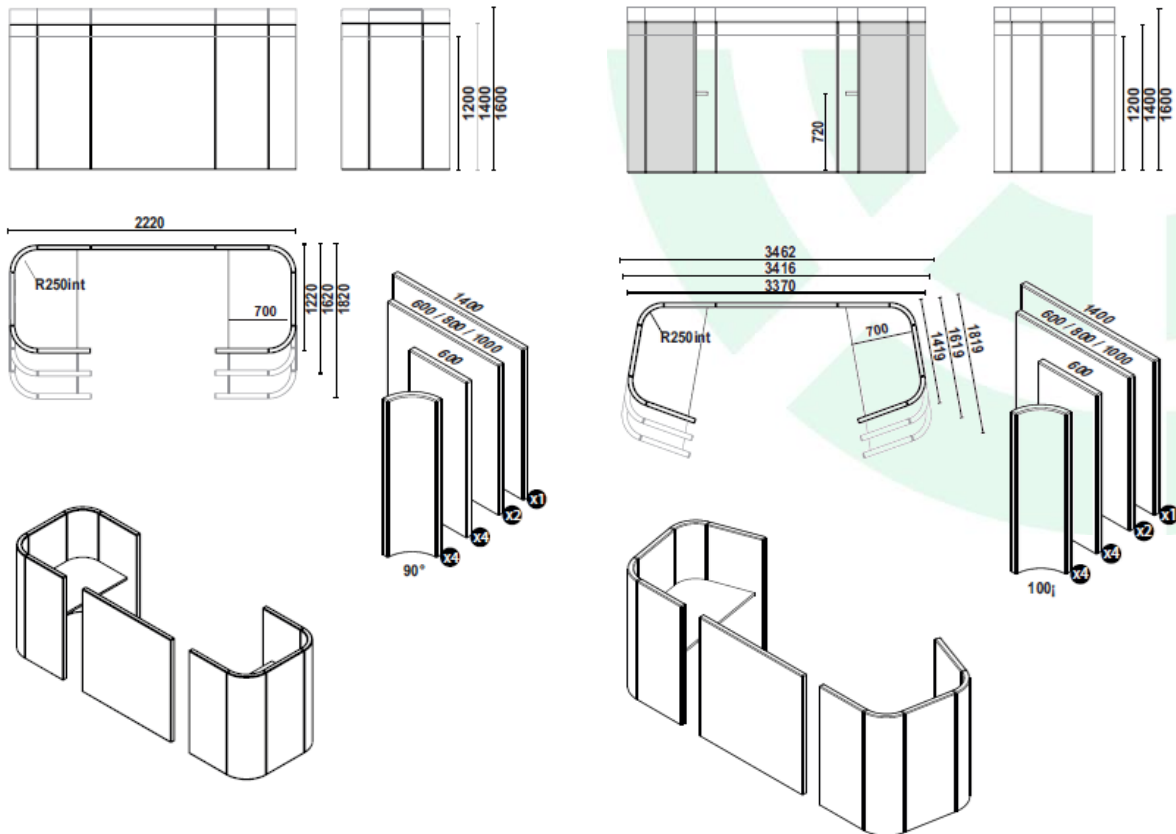

 50 > 61
50 > 61

 7 weeks
7 weeks

FIT C WORKSTATION 90° & 100°





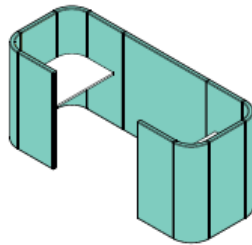

FIT C WORKSTATION 90°

- 
Cat 1
 Camira Cara
 Camira Carlow
 Camira Urban
 Camira Xtreme
 Fidivi King Flex
- 
Cat 2
 Camira Main Line Flax
 Camira Main Line Plus
 Camira Xtreme CS (M1)
- 
Cat 3
 Camira Blazer
 Camira Blazer Lite
 Camira Synergy
- 
Cat 4
 Kvadrat Gabriel Step
 Kvadrat Revive 1/2
 Kvadrat San
 Kvadrat Remix 2
 Kvadrat Steelcutrio
 Kvadrat Canvas
 Kvadrat Divinamelange 2



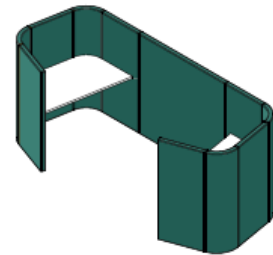

FIT C WORKSTATION 100°

- 
Cat 1
 Camira Cara
 Camira Carlow
 Camira Urban
 Camira Xtreme
 Fidivi King Flex
- 
Cat 2
 Camira Main Line Flax
 Camira Main Line Plus
 Camira Xtreme CS (M1)
- 
Cat 3
 Camira Blazer
 Camira Blazer Lite
 Camira Synergy
- 
Cat 4
 Kvadrat Gabriel Step
 Kvadrat Revive 1/2
 Kvadrat San
 Kvadrat Remix 2
 Kvadrat Steelcutrio
 Kvadrat Canvas
 Kvadrat Divinamelange 2



FIT C WORKSTATION 90°
FIT C WORKSTATION 100°

 800 > 1800 mm
1200-1400-1600 mm

 1220-1620-1820 mm
1419-1619-1819 mm



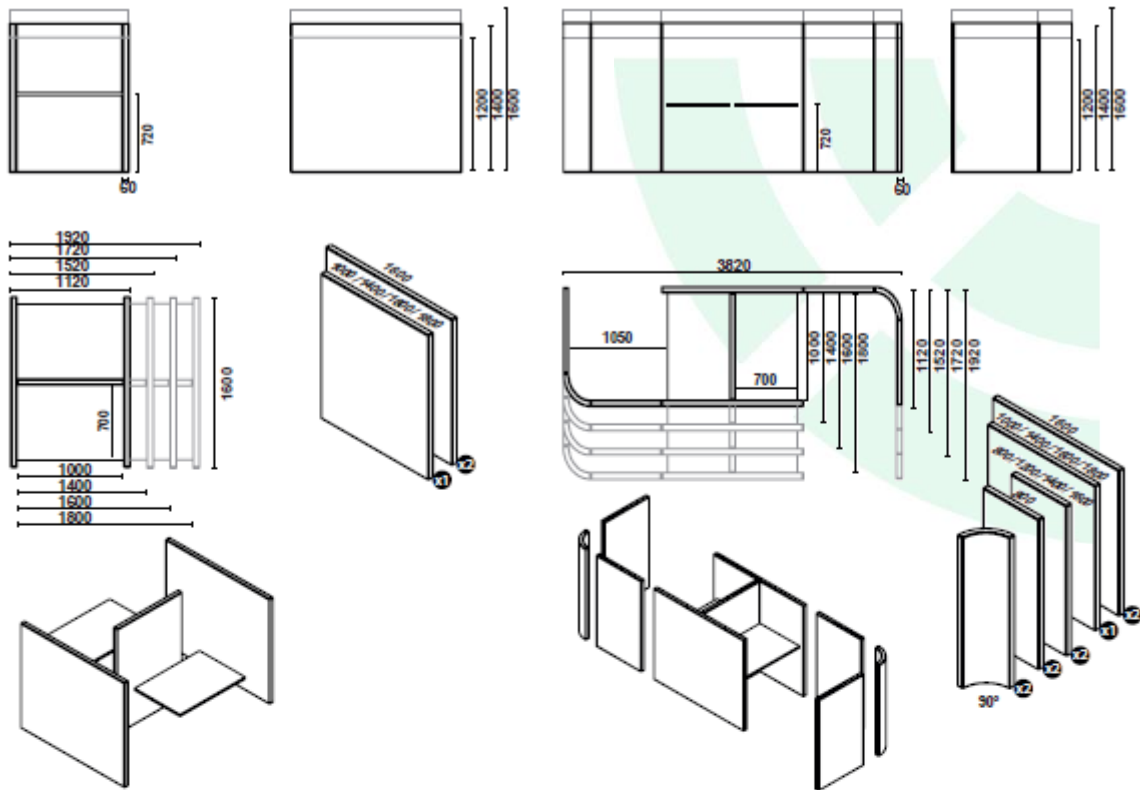

 70 > 83
70 > 83

 7 weeks
7 weeks

FIT H WORKSTATION





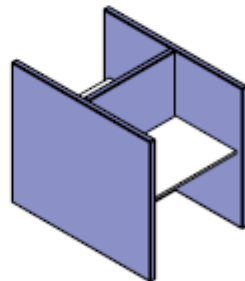

FIT H WORKSTATION

-  **Cat 1**
Camira Cara
Camira Carlow
Camira Urban
Camira Xtreme
Fidivi King Flex
-  **Cat 2**
Camira Main Line Flex
Camira Main Line Plus
Camira Xtreme CS (M1)
-  **Cat 3**
Camira Blazer
Camira Blazer Lite
Camira Synergy
-  **Cat 4**
Kvadrat Gabriel Step
Kvadrat Revivo 1/2
Kvadrat San
Kvadrat Remix 2
Kvadrat Steelcutrio
Kvadrat Canvas
Kvadrat Divinamolange 2



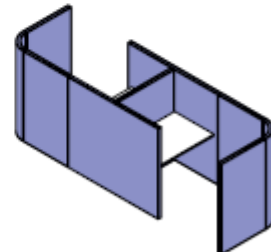

FIT H WORKSTATION+ WALLS

-  **Cat 1**
Camira Cara
Camira Carlow
Camira Urban
Camira Xtreme
Fidivi King Flex
-  **Cat 2**
Camira Main Line Flex
Camira Main Line Plus
Camira Xtreme CS (M1)
-  **Cat 3**
Camira Blazer
Camira Blazer Lite
Camira Synergy
-  **Cat 4**
Kvadrat Gabriel Step
Kvadrat Revivo 1/2
Kvadrat San
Kvadrat Remix 2
Kvadrat Steelcutrio
Kvadrat Canvas
Kvadrat Divinamolange 2



FIT H WORKSTATION
FIT H WORKSTATION+ WALLS



800 > 1800 mm
1200-1400-1600 mm

600 > 2000 mm
1419-1619-1819 mm

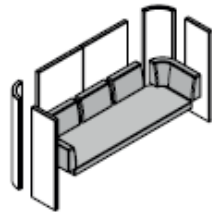
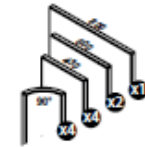
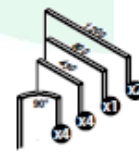
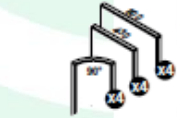
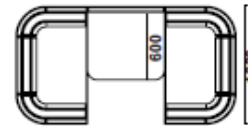
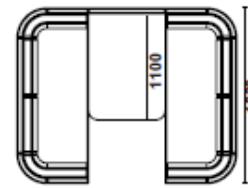
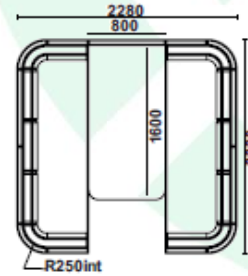
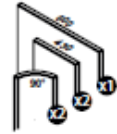
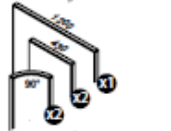
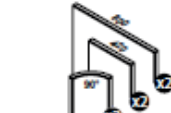
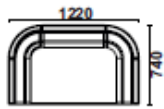
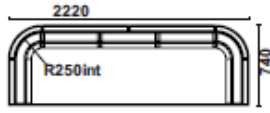
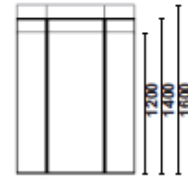
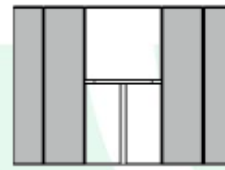
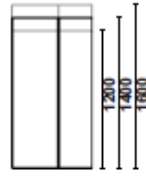
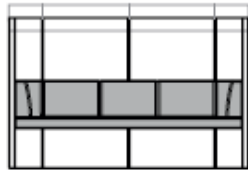

70 > 83
70 > 83

7 weeks
7 weeks

FIT SOFA & CELL

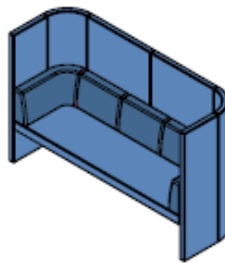

FIT SOFA design by Alain Berteau



FIT CELL

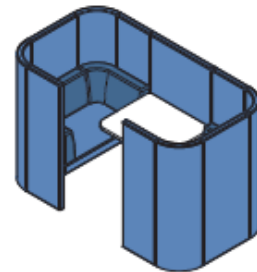

FIT SOFA
FIT CELL

↑
1200-1400-1600 mm
1200-1400-1600 mm

→
1220-1820-2220 mm
1220-1820-2220 mm



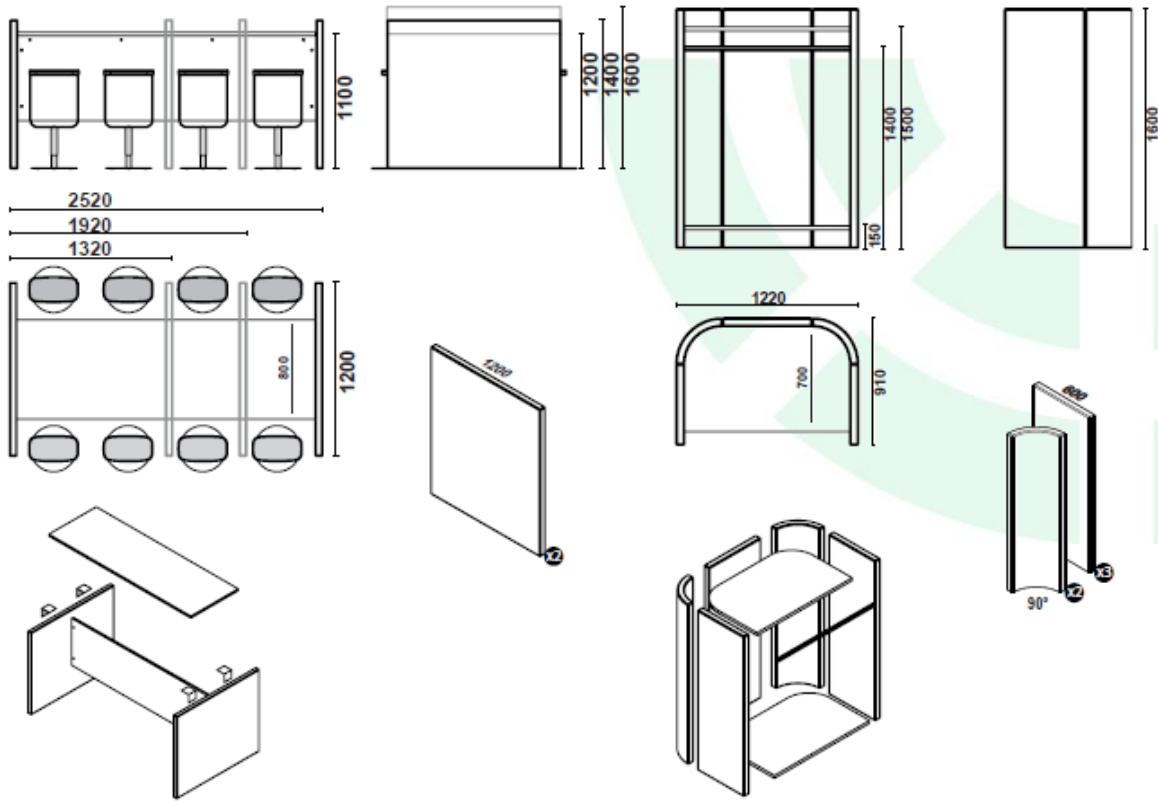

kg
53 > 104
126 > 218

🕒
7 weeks
7 weeks

FIT BAR & U WARDROBE





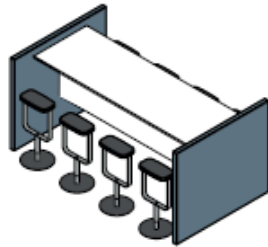

FIT BAR

- 
Cat 1
 Camira Cara
 Camira Carlow
 Camira Urban
 Camira Xtreme
 Fidivi King Flex
- 
Cat 2
 Camira Main Line Flax
 Camira Main Line Plus
 Camira Xtreme CS (M1)
- 
Cat 3
 Camira Blazer
 Camira Blazer Lite
 Camira Synergy
- 
Cat 4
 Kvadrat Gabriel Step
 Kvadrat Revive 1/2
 Kvadrat San
 Kvadrat Remix 2
 Kvadrat Steelcutrio
 Kvadrat Canvas
 Kvadrat Divinamelange 2



FIT U WARDROBE

- 
Cat 1
 Camira Cara
 Camira Carlow
 Camira Urban
 Camira Xtreme
 Fidivi King Flex
- 
Cat 2
 Camira Main Line Flax
 Camira Main Line Plus
 Camira Xtreme CS (M1)
- 
Cat 3
 Camira Blazer
 Camira Blazer Lite
 Camira Synergy
- 
Cat 4
 Kvadrat Gabriel Step
 Kvadrat Revive 1/2
 Kvadrat San
 Kvadrat Remix 2
 Kvadrat Steelcutrio
 Kvadrat Canvas
 Kvadrat Divinamelange 2



FIT BAR
FIT U WARDROBE



1200-1400-1600 mm
1200-1400-1600 mm

2520 mm
1220 mm



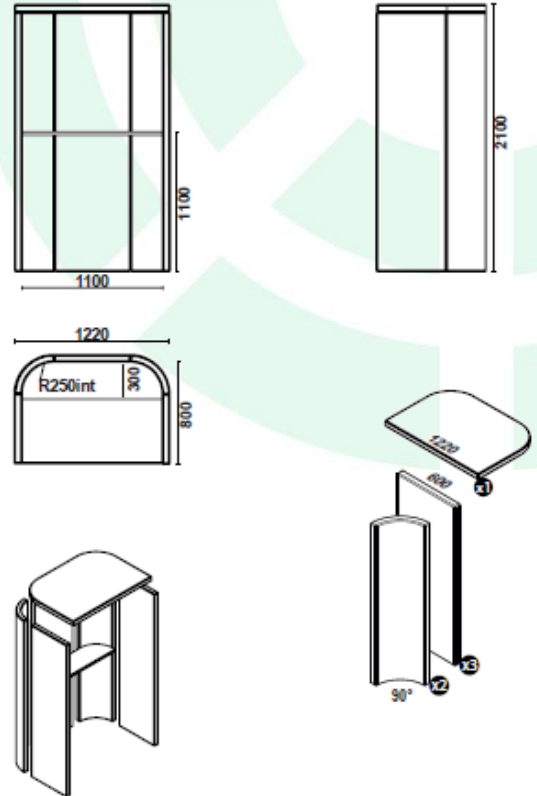
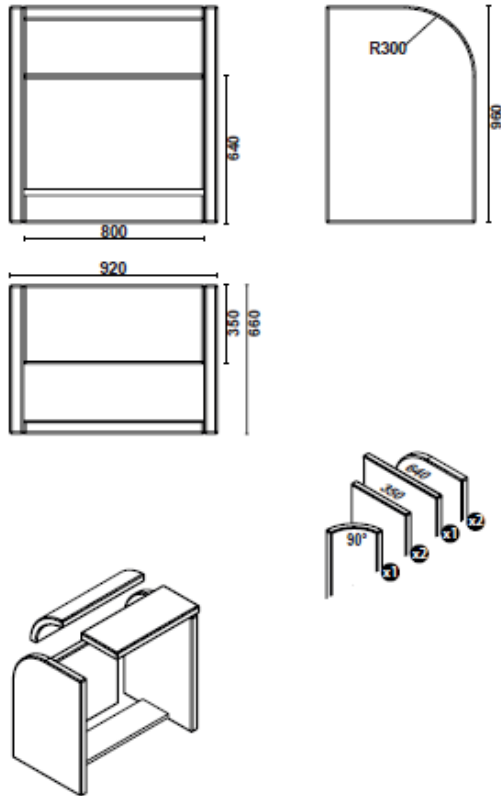

85 > 93
51



7 weeks
7 weeks

FIT HOOD SMALL & HOOD LARGE





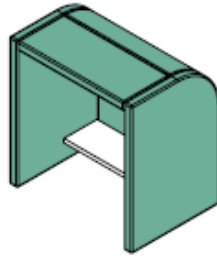

FIT HOOD SMALL

-  **Cat 1**
Camira Cara
Camira Carlow
Camira Urban
Camira Xtreme
Fidivi King Flex
-  **Cat 2**
Camira Main Line Flax
Camira Main Line Plus
Camira Xtreme CS (M1)
-  **Cat 3**
Camira Blazer
Camira Blazer Lite
Camira Synergy
-  **Cat 4**
Kvadrat Gabriel Step
Kvadrat Revive 1/2
Kvadrat San
Kvadrat Remix 2
Kvadrat Steelcutrio
Kvadrat Canvas
Kvadrat Divinamelange 2



FIT HOOD LARGE

-  **Cat 1**
Camira Cara
Camira Carlow
Camira Urban
Camira Xtreme
Fidivi King Flex
-  **Cat 2**
Camira Main Line Flax
Camira Main Line Plus
Camira Xtreme CS (M1)
-  **Cat 3**
Camira Blazer
Camira Blazer Lite
Camira Synergy
-  **Cat 4**
Kvadrat Gabriel Step
Kvadrat Revive 1/2
Kvadrat San
Kvadrat Remix 2
Kvadrat Steelcutrio
Kvadrat Canvas
Kvadrat Divinamelange 2

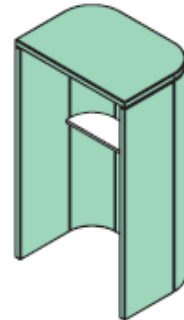

FIT HOOD SMALL
FIT HOOD LARGE



960 mm
2100 mm

920 mm
1220 mm



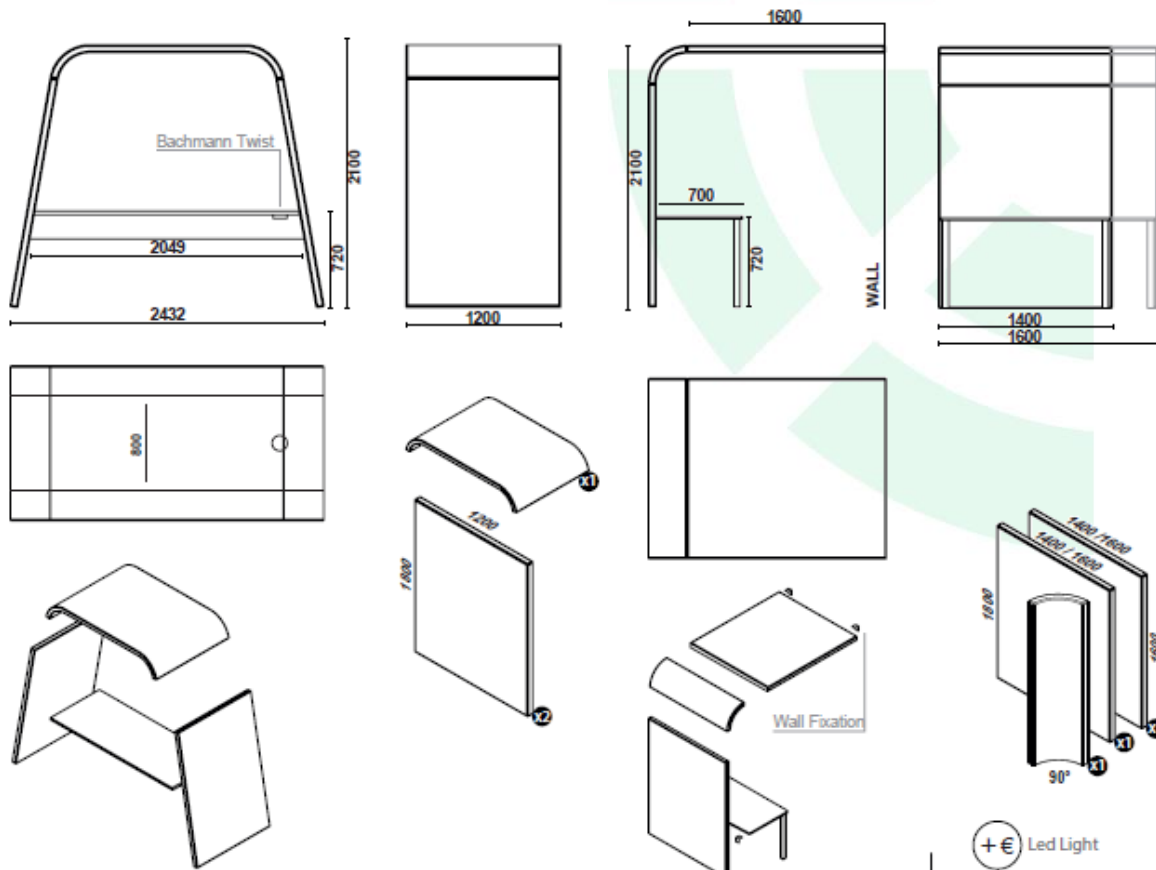

25
75



7 weeks
7 weeks

FIT BRIDGE & WALL BRIDGE



FIT BRIDGE

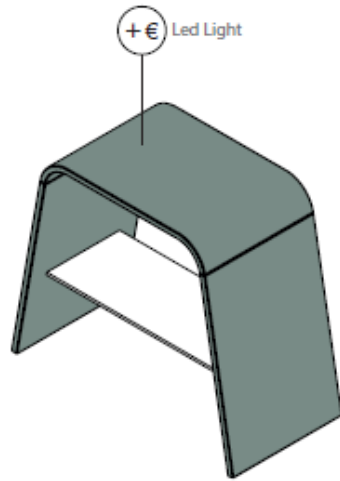



-  **Cat 1**
Camira Cara
Camira Carlow
Camira Urban
Camira Xtreme
Fidivi King Flex
-  **Cat 2**
Camira Main Line Flax
Camira Main Line Plus
Camira Xtreme CS (M1)
-  **Cat 3**
Camira Blazer
Camira Blazer Lite
Camira Synergy
-  **Cat 4**
Kvadrat Gabriel Step
Kvadrat Revive 1/2
Kvadrat San
Kvadrat Remix 2
Kvadrat Steelcutrio
Kvadrat Canvas
Kvadrat Divinamelange 2



FIT BRIDGE
FIT WALL BRIDGE



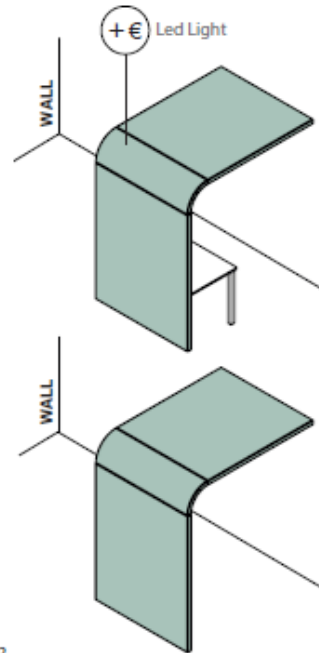

 2100 mm
 2100 mm

FIT WALL BRIDGE

-  **Cat 1**
Camira Cara
Camira Carlow
Camira Urban
Camira Xtreme
Fidivi King Flex
-  **Cat 2**
Camira Main Line Flax
Camira Main Line Plus
Camira Xtreme CS (M1)
-  **Cat 3**
Camira Blazer
Camira Blazer Lite
Camira Synergy
-  **Cat 4**
Kvadrat Gabriel Step
Kvadrat Revive 1/2
Kvadrat San
Kvadrat Remix 2
Kvadrat Steelcutrio
Kvadrat Canvas
Kvadrat Divinamelange 2



 2432mm
 1220 mm

 148 kg
 7 weeks
 93 > 105 kg
 7 weeks

TABLES



FIT U WORKSTATION 90°

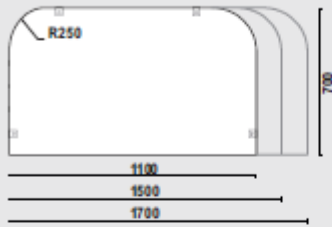

FIT U WORKSTATION 100°

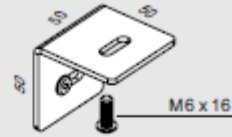
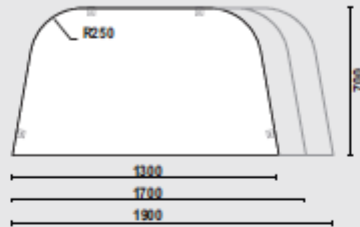

FIT E WORKSTATION

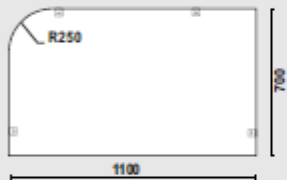

FIT H WORKSTATION

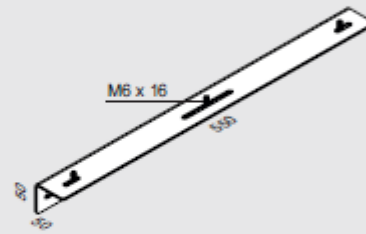
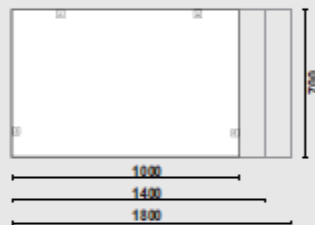

FIT CELL 2 P

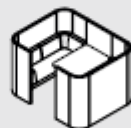

FIT CELL 4 P

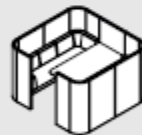

FIT CELL 6 P

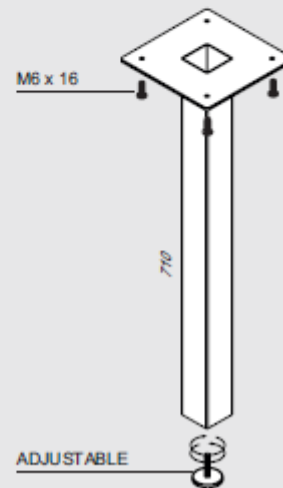

black - white - grey

TABLES TOP FINISHES

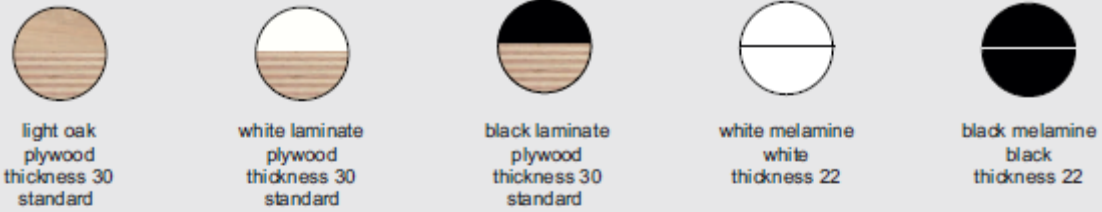

TABLES TOP ACCESSORIES

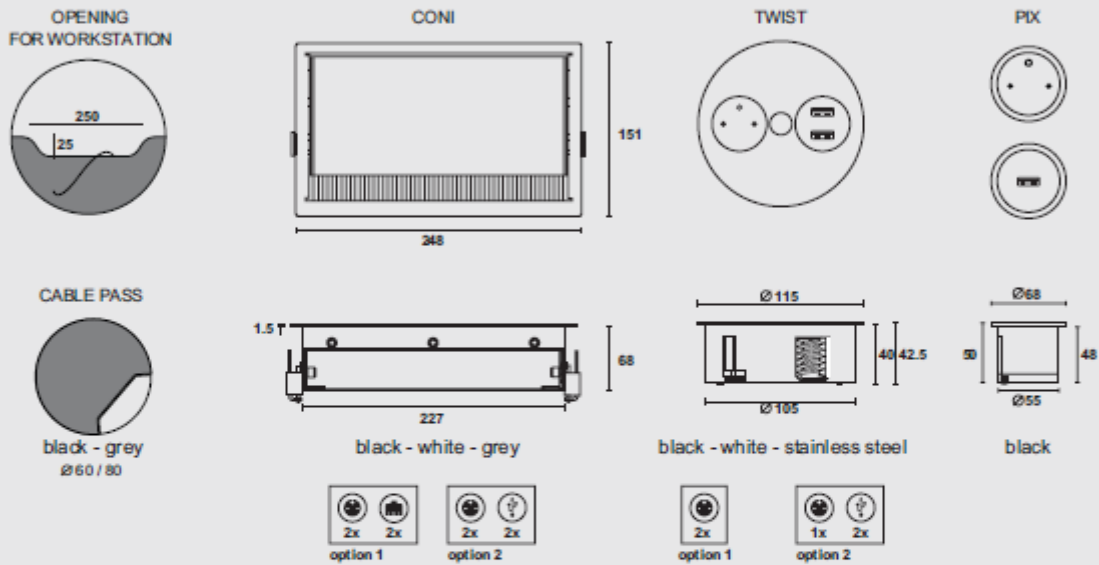

ELECTRICAL PLUGS



The electrical component is centered on the top of the table, on the partition side.

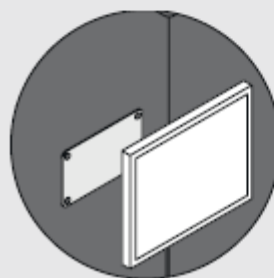

Screen dimensions needed in order.