

SURFACES

design wandpanelen, schermen & baffels

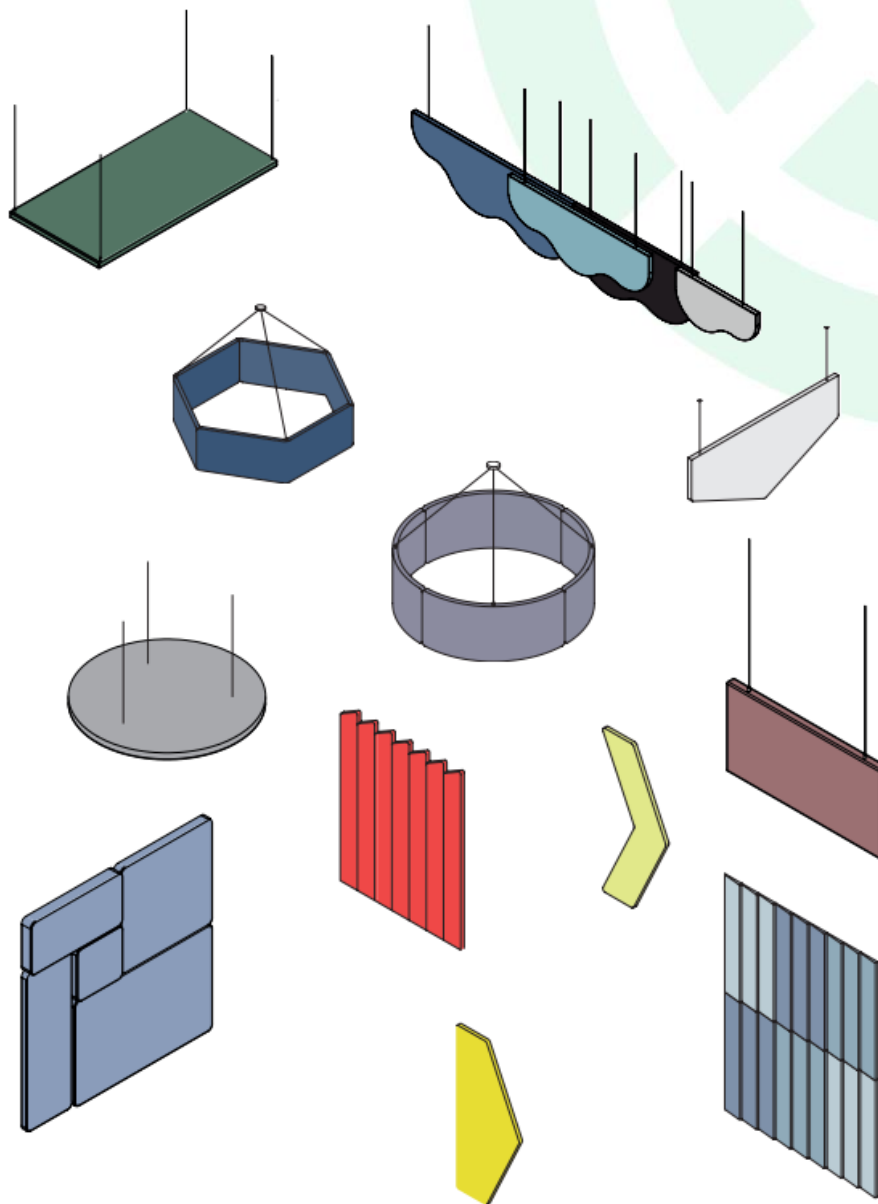

Deze akoestische DESIGN oplossingen, special ontworpen door Julien Renault & Alain Berteau, bieden de (interieur)architecten creatieve vrijheid in hun akoestische ontwerpen en beantwoorden aan zowel de esthetische als akoestische eisen van elk interieur.

VOORDELEN

- ✓ Keuze uit meerdere vormen
- ✓ Keuze uit 200+ kleuren
- ✓ Flexibel
- ✓ Eenvoudig te plaatsen
- ✓ Strak ontwerp

SKY – DESIGN BY JULIEN RENAULT

- 🌀 **Materiaal:** Kern van akoestisch schuimstof
- 🌀 **Afmetingen:** 800 x 400 x 40 mm, 1200 x 600 x 40 mm, 1400 x 500 x 40mm, 1600 x 600 x 40 mm
- 🌀 **Absorptie:** $\alpha_w = 1.00$ / Absorptieklasse = A

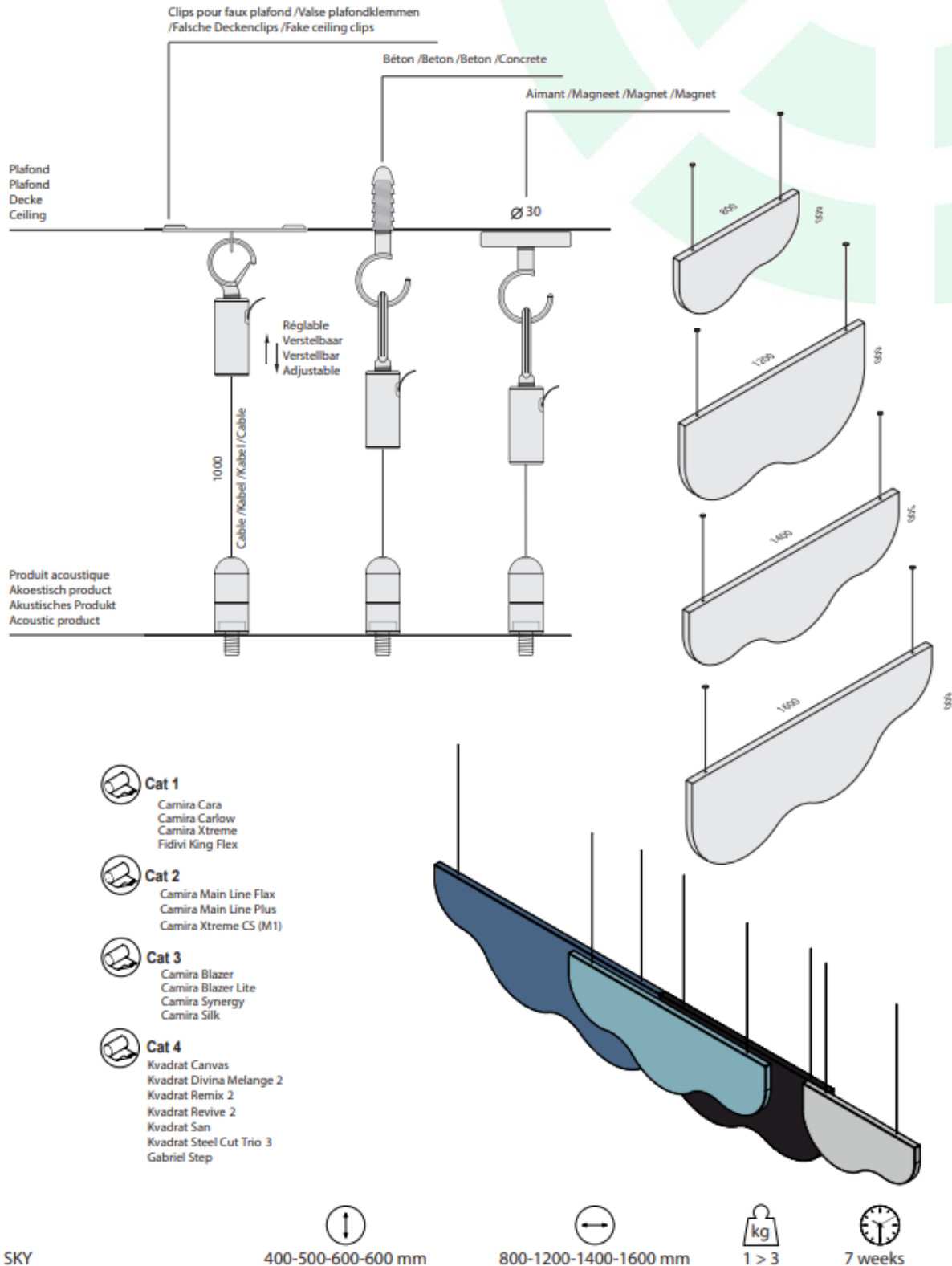

FOLD – DESIGN BY JULIEN RENAULT

 **Materiaal:** Kern van akoestisch schuimstof

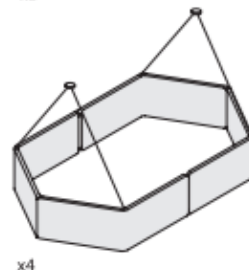
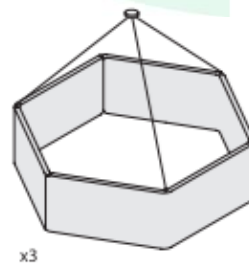
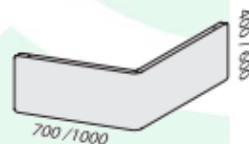
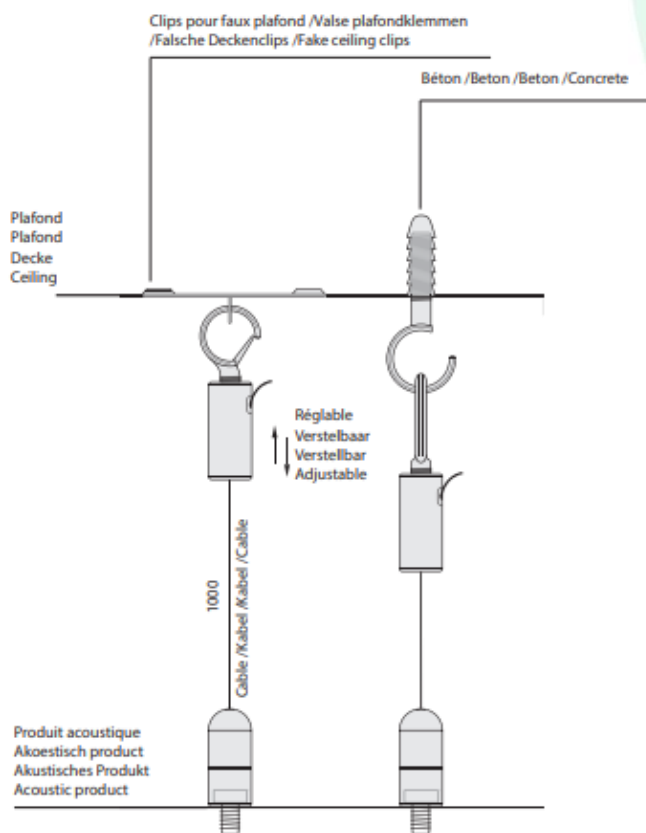

Cat 1

- Camira Cara
- Camira Carlow
- Camira Xtreme
- Fidivi King Flex



Cat 2

- Camira Main Line Flex
- Camira Main Line Plus
- Camira Xtreme CS (M1)



Cat 3

- Camira Blazer
- Camira Blazer Lite
- Camira Synergy
- Camira Silk



Cat 4

- Kvadrat Canvas
- Kvadrat Divina Melange 2
- Kvadrat Remix 2
- Kvadrat Revive 2
- Kvadrat San
- Kvadrat Steel Cut Trio 3
- Gabriel Step

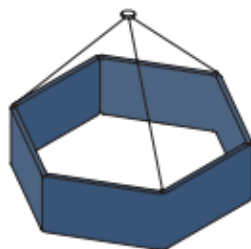

FOLD



400-600 mm



1300-1800 mm



4 > 7





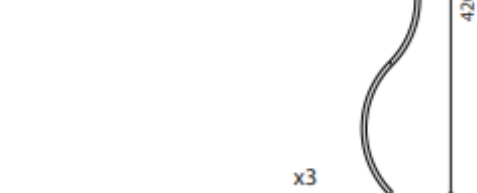
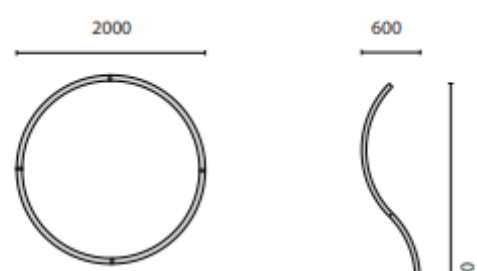
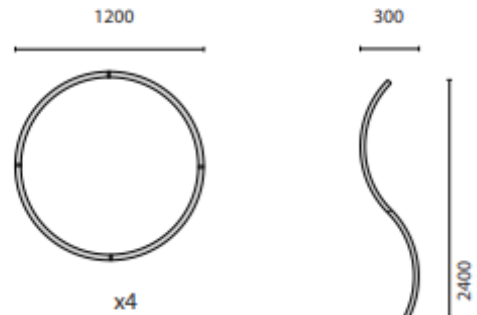
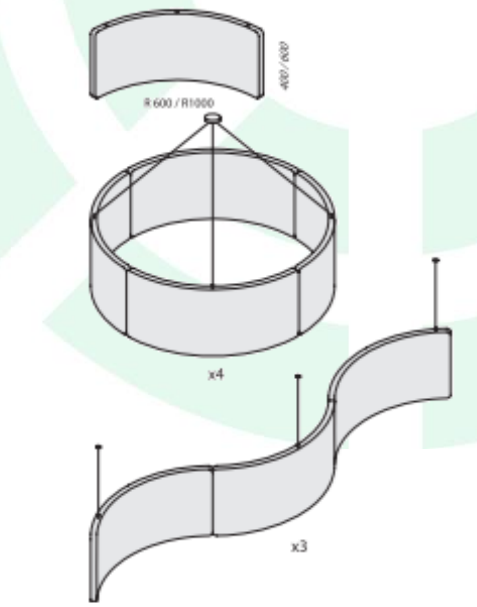
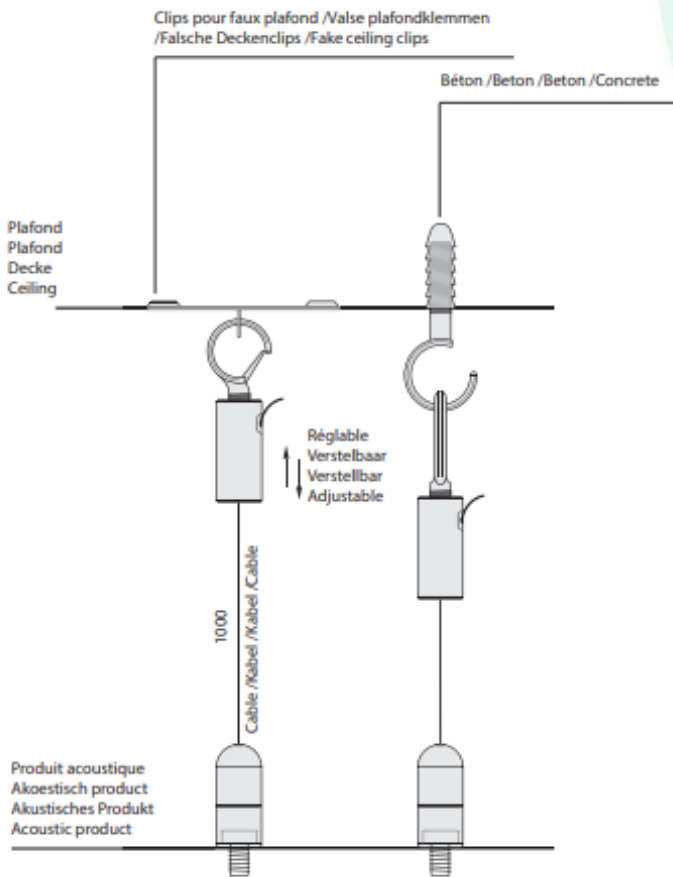

7 weeks

SLICE – DESIGN BY ALAIN BERTEAU

 **Materiaal:** Kern van akoestisch schuimstof



-  **Cat 1**
Camira Cara
Camira Carlow
Camira Xtreme
Fidivi King Flex
-  **Cat 2**
Camira Main Line Flax
Camira Main Line Plus
Camira Xtreme CS (M1)
-  **Cat 3**
Camira Blazer
Camira Blazer Lite
Camira Synergy
Camira Silk
-  **Cat 4**
Kvadrat Canvas
Kvadrat Divina Melange 2
Kvadrat Remix 2
Kvadrat Revive 2
Kvadrat San
Kvadrat Steel Cut Trio 3
Gabriel Step



400-600 mm



600-1000 mm



4 > 7







7 weeks

SLICE

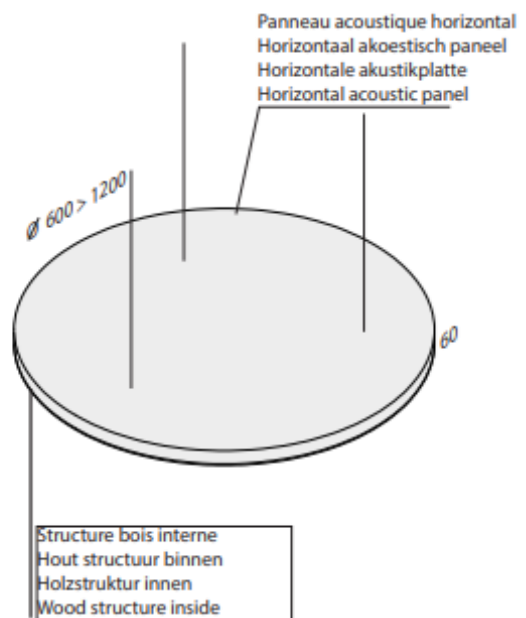
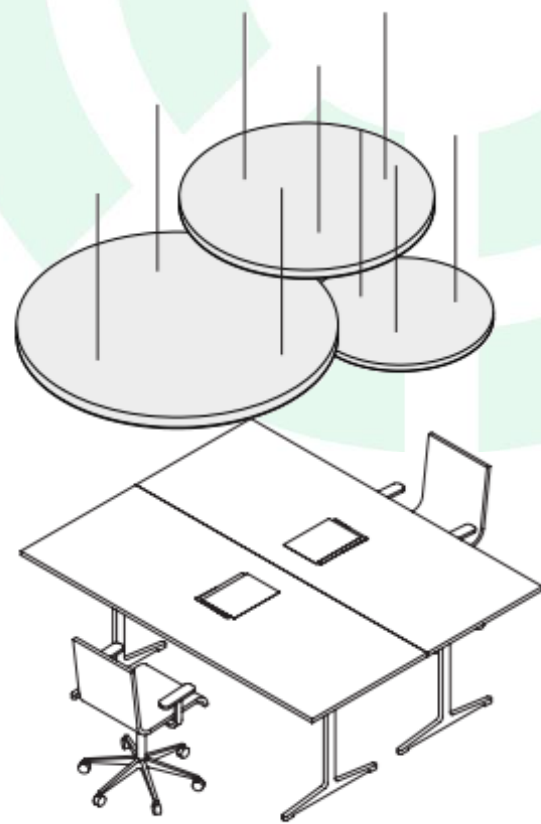
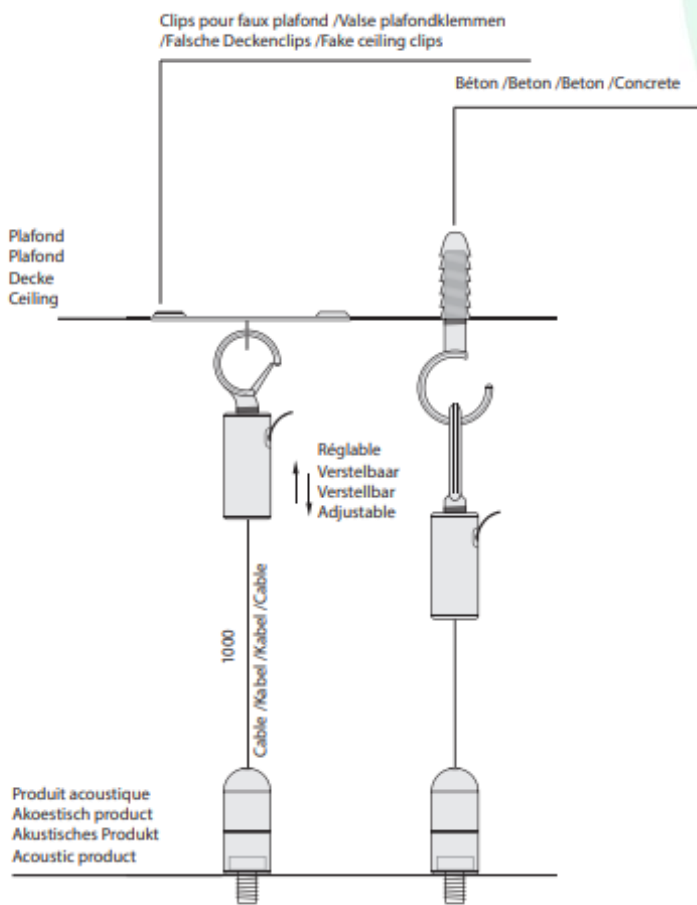
CIRCLE

 **Materiaal:** Kern van akoestisch schuimstof



-  **Cat 1**
Camira Cara
Camira Carlow
Camira Xtreme
Fidivi King Flex
-  **Cat 2**
Camira Main Line Flax
Camira Main Line Plus
Camira Xtreme CS (M1)
-  **Cat 3**
Camira Blazer
Camira Blazer Lite
Camira Synergy
Camira Silk
-  **Cat 4**
Kvadrat Canvas
Kvadrat Divina Melange 2
Kvadrat Remix 2
Kvadrat Revive 2
Kvadrat San
Kvadrat Steel Cut Trio 3
Gabriel Step

CIRCLE



60 mm

400-600-800-1000-1200 mm

2 > 5

7 weeks

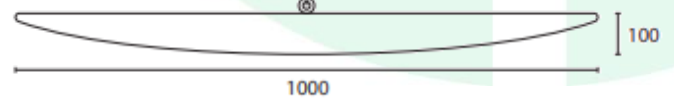
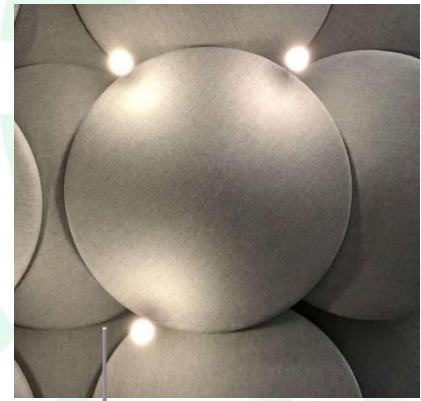
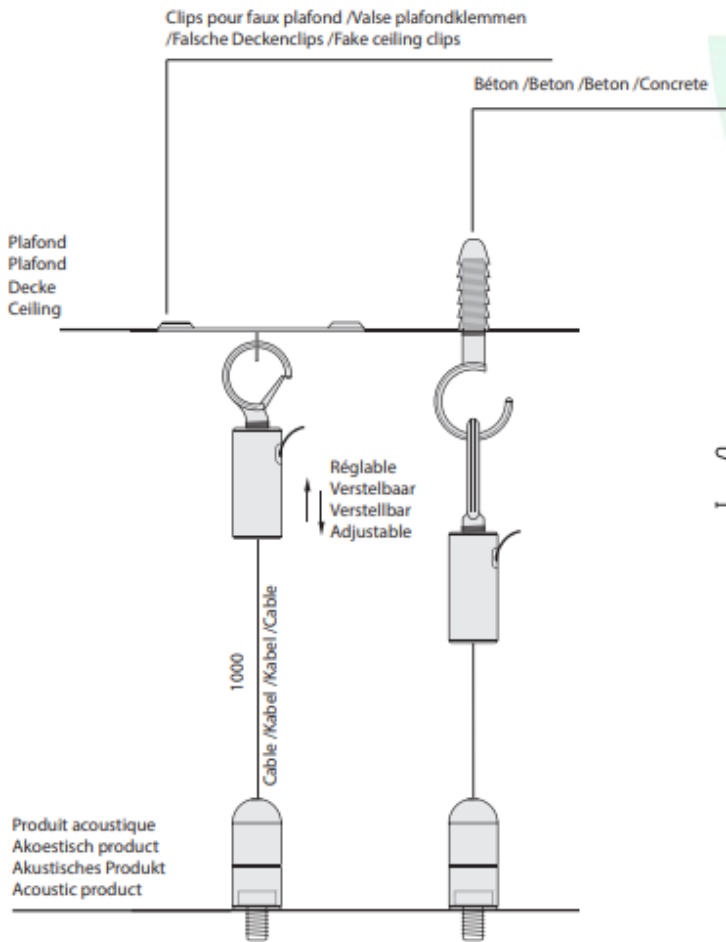
MUSHROOMS



Cat 3
 Camira Blazer
 Camira Blazer Lite
 Camira Synergy



100 mm



1000 mm







6

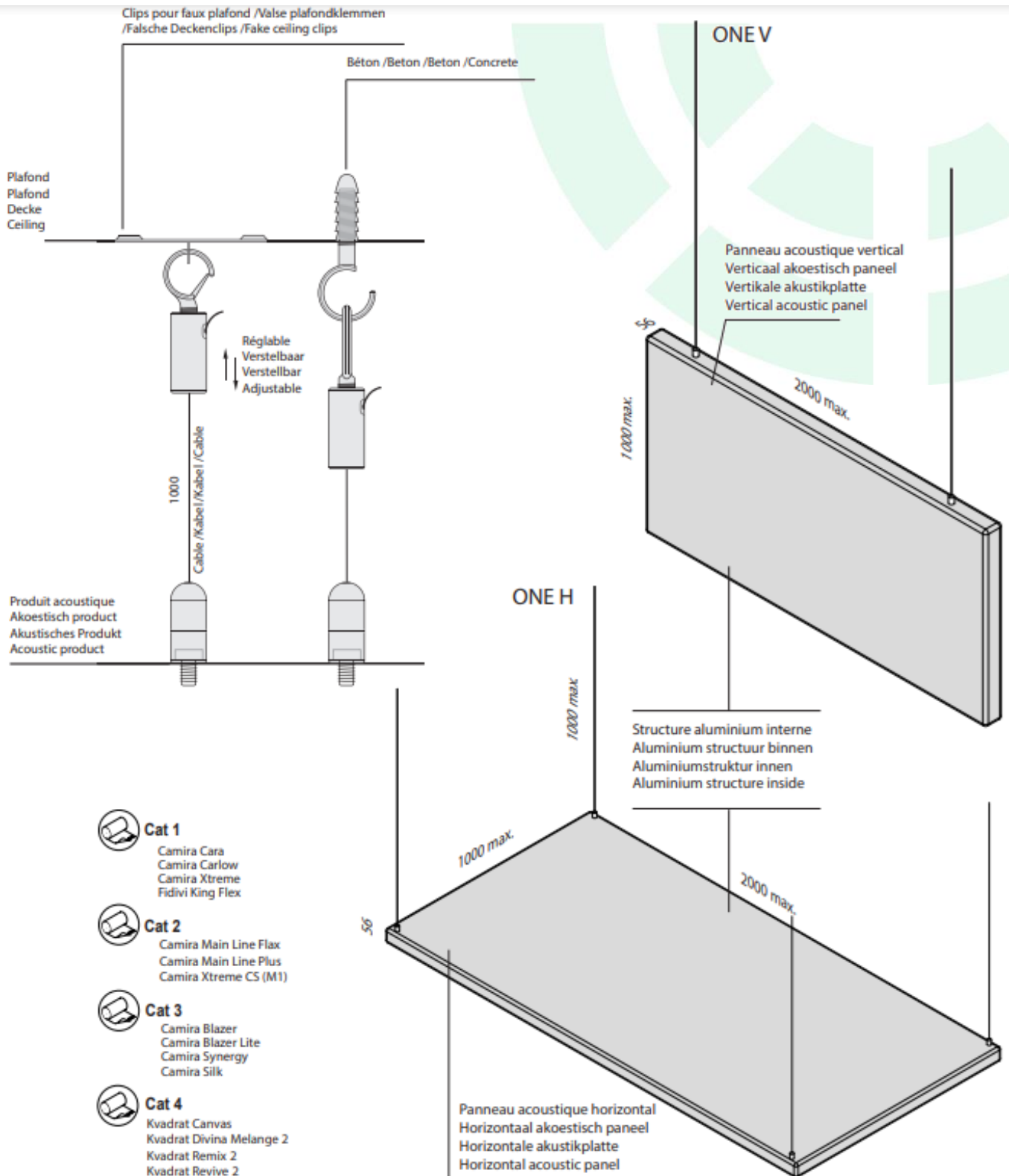

8 weeks

RECTANGLE – ONE V / ONE H



-  **Cat 1**
Camira Cara
Camira Carlow
Camira Xtreme
Fidivi King Flex
-  **Cat 2**
Camira Main Line Flax
Camira Main Line Plus
Camira Xtreme CS (M1)
-  **Cat 3**
Camira Blazer
Camira Blazer Lite
Camira Synergy
Camira Silk
-  **Cat 4**
Kvadrat Canvas
Kvadrat Divina Melange 2
Kvadrat Remix 2
Kvadrat Revive 2
Kvadrat San
Kvadrat Steel Cut Trio 3
Gabriel Step

RECTANGLE ONE H - ONE V

 600-800-1000 mm

 1000-1200-1400-1600-1800-2000 mm

 3 > 8

 8 weeks

RECTANGLE – THREE

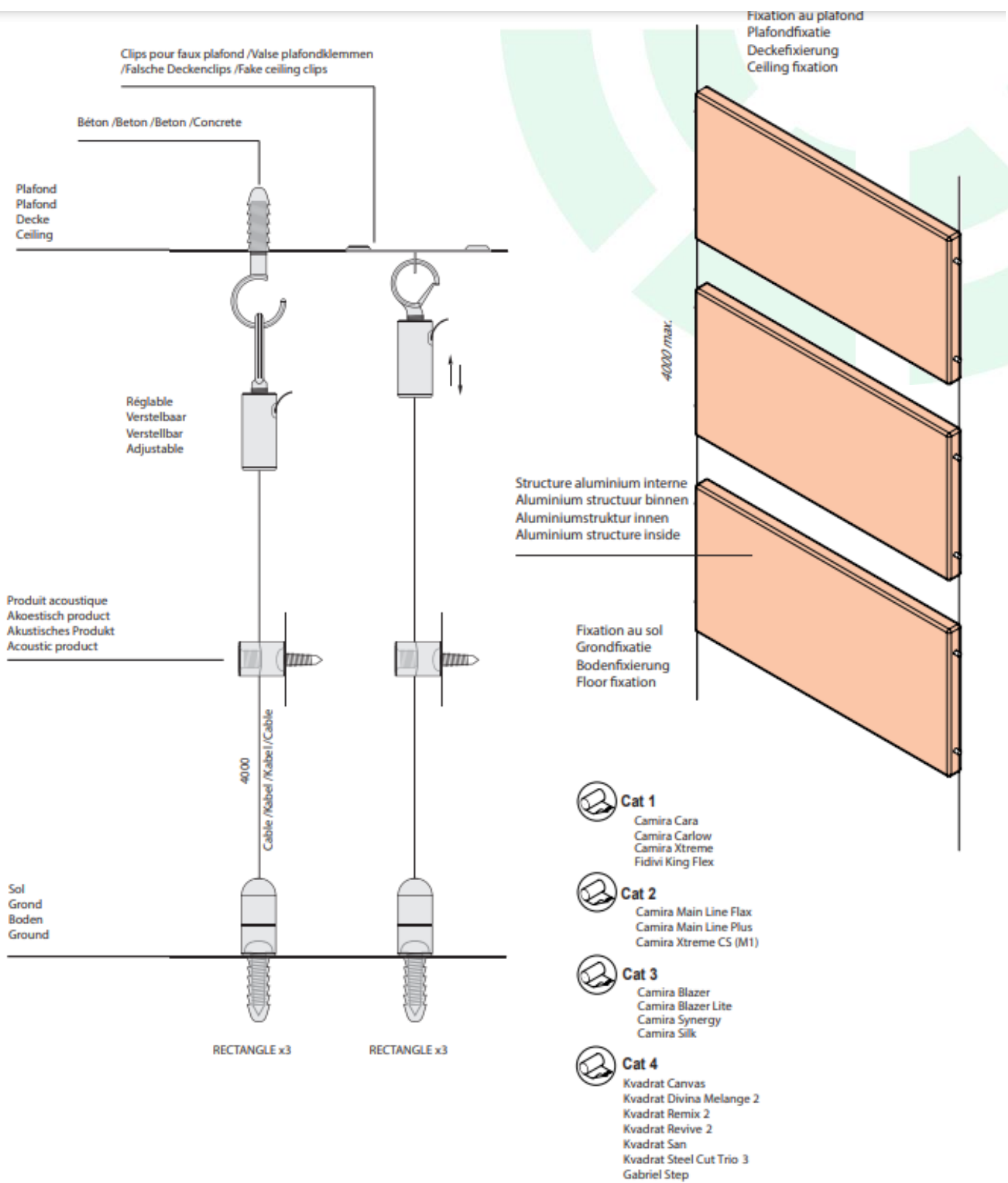

RECTANGLE THREE

400-600-800 mm

1000-1200-1400-1600-1800-2000 mm

12 > 18

8 weeks

PAVING 3D – DESIGN BY ALAIN BERTEAU / JULIEN RENAULT

- 🌀 **Materiaal:** Kern van akoestisch schuimstof, geperforeerd paneel
- 🌀 **Bevestiging:** Velcro
- 🌀 **Absorptie:** $\alpha_w = 0.45$ (MH) / Absorptieklasse = D

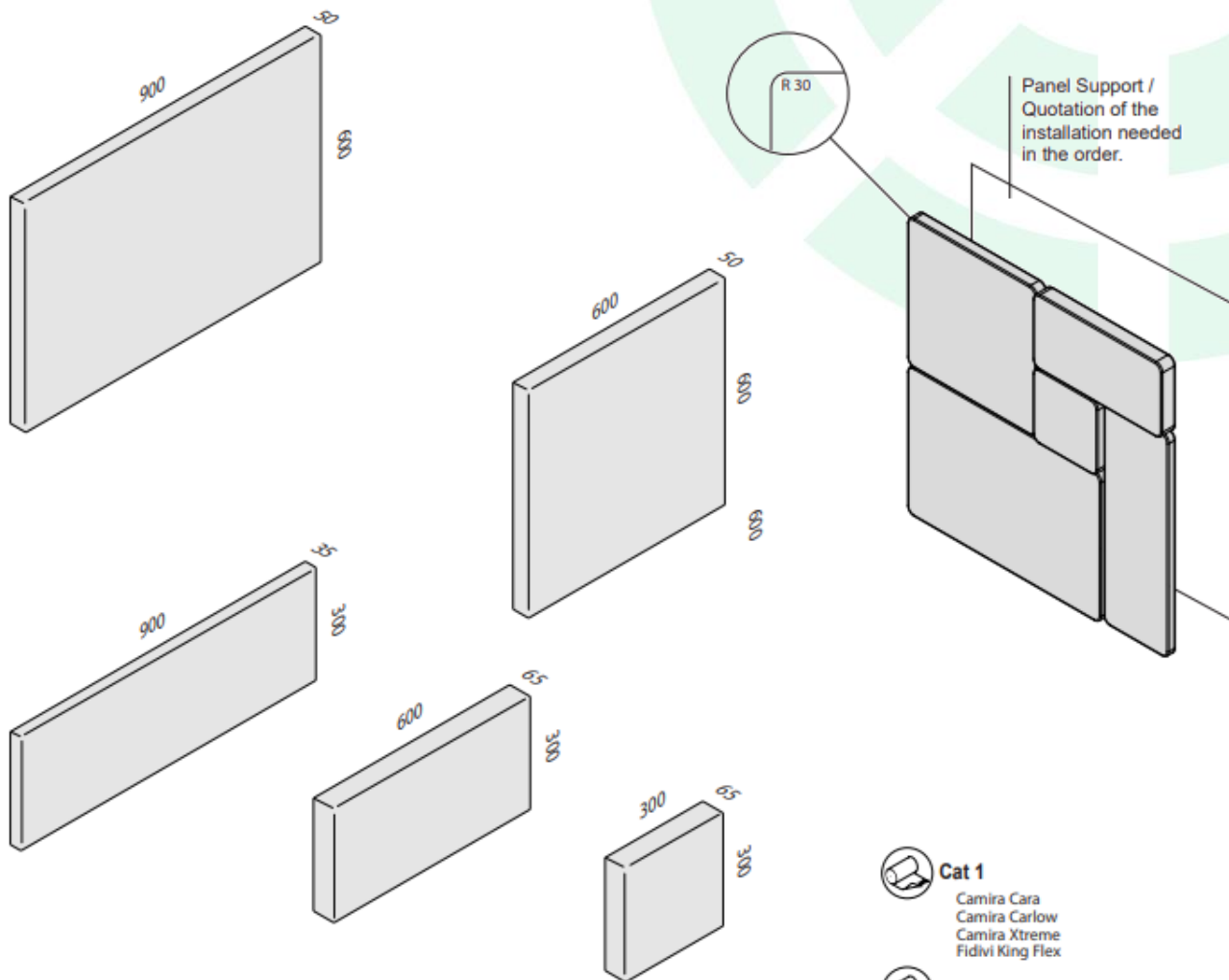

ONE FABRIC REFERENCE BY MODULE

1 MODULE = 1.44 m²

ONLY AVAILABLE AS 1.44 m² / 5 ELEMENTS



Cat 1

Camira Cara
Camira Carlow
Camira Xtreme
Fidivi King Flex



Cat 2

Camira Main Line Flax
Camira Main Line Plus
Camira Xtreme CS (M1)



Cat 3

Camira Blazer
Camira Blazer Lite
Camira Synergy
Camira Silk



Cat 4

Kvadrat Canvas
Kvadrat Divina Melange 2
Kvadrat Remix 2
Kvadrat Revive 2
Kvadrat San
Kvadrat Steel Cut Trio 3
Gabriel Step

PAVING 3D



1200 mm



1200 mm



6



8 weeks

FENCE – DESIGN BY JULIEN RENAULT

- 🌀 **Materiaal:** Kern van akoestisch schuimstof, geperforeerd paneel
- 🌀 **Bevestiging:** Velcro
- 🌀 **Absorptie:** $\alpha_w = 0.45$ (MH) / Absorptieklasse = D

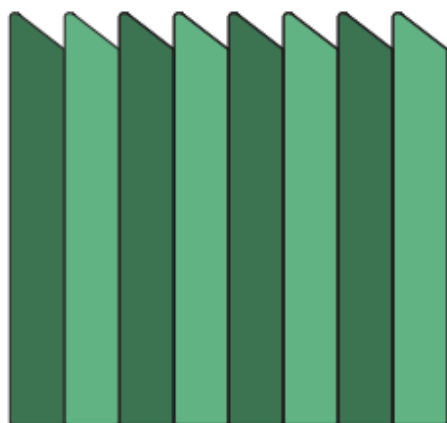

20

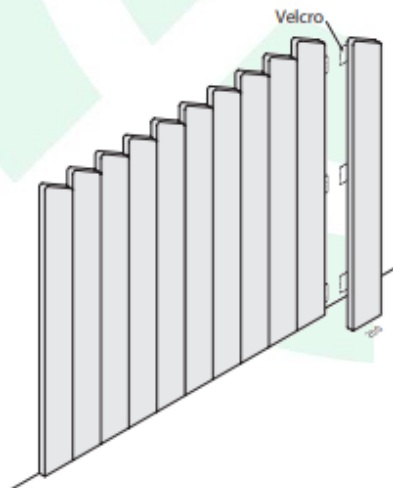

Cat 1

Camira Cara
Camira Carlow
Camira Xtreme
Fidivi King Flex



Cat 2

Camira Main Line Flax
Camira Main Line Plus
Camira Xtreme CS (M1)



Cat 3

Camira Blazer
Camira Blazer Lite
Camira Synergy
Camira Silk



Cat 4

Kvadrat Canvas
Kvadrat Divina Melange 2
Kvadrat Remix 2
Kvadrat Revive 2
Kvadrat San
Kvadrat Steel Cut Trio 3
Gabriel Step



FENCE



1200 mm



1200 mm



3



8 weeks

PLANK – JULIEN RENAULT

- 🌀 **Materiaal:** Kern van akoestisch schuimstof, geperforeerd paneel
- 🌀 **Bevestiging:** Velcro
- 🌀 **Absorptie:** $\alpha_w = 0.60$ (MH) / Absorptieklasse = C

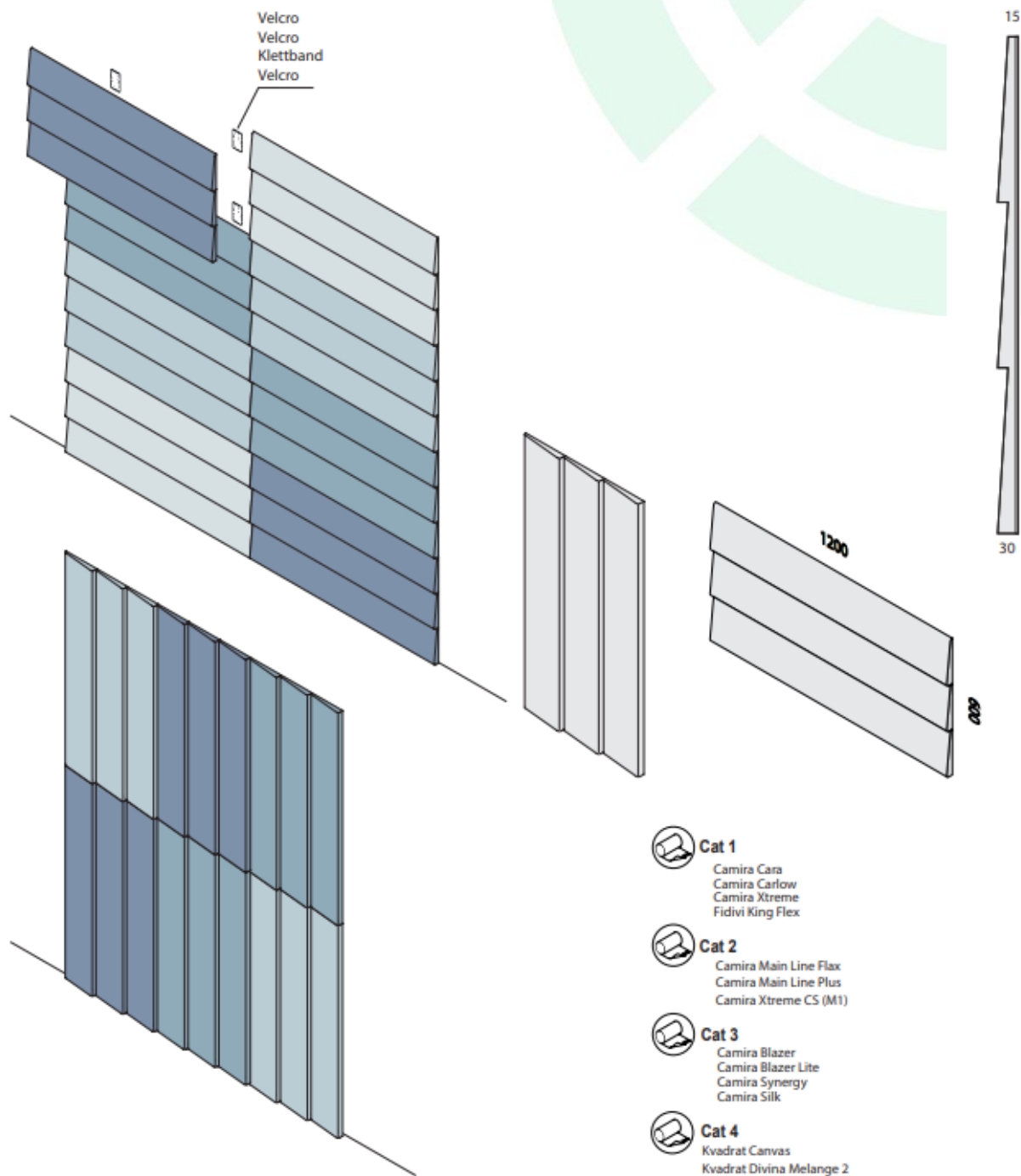



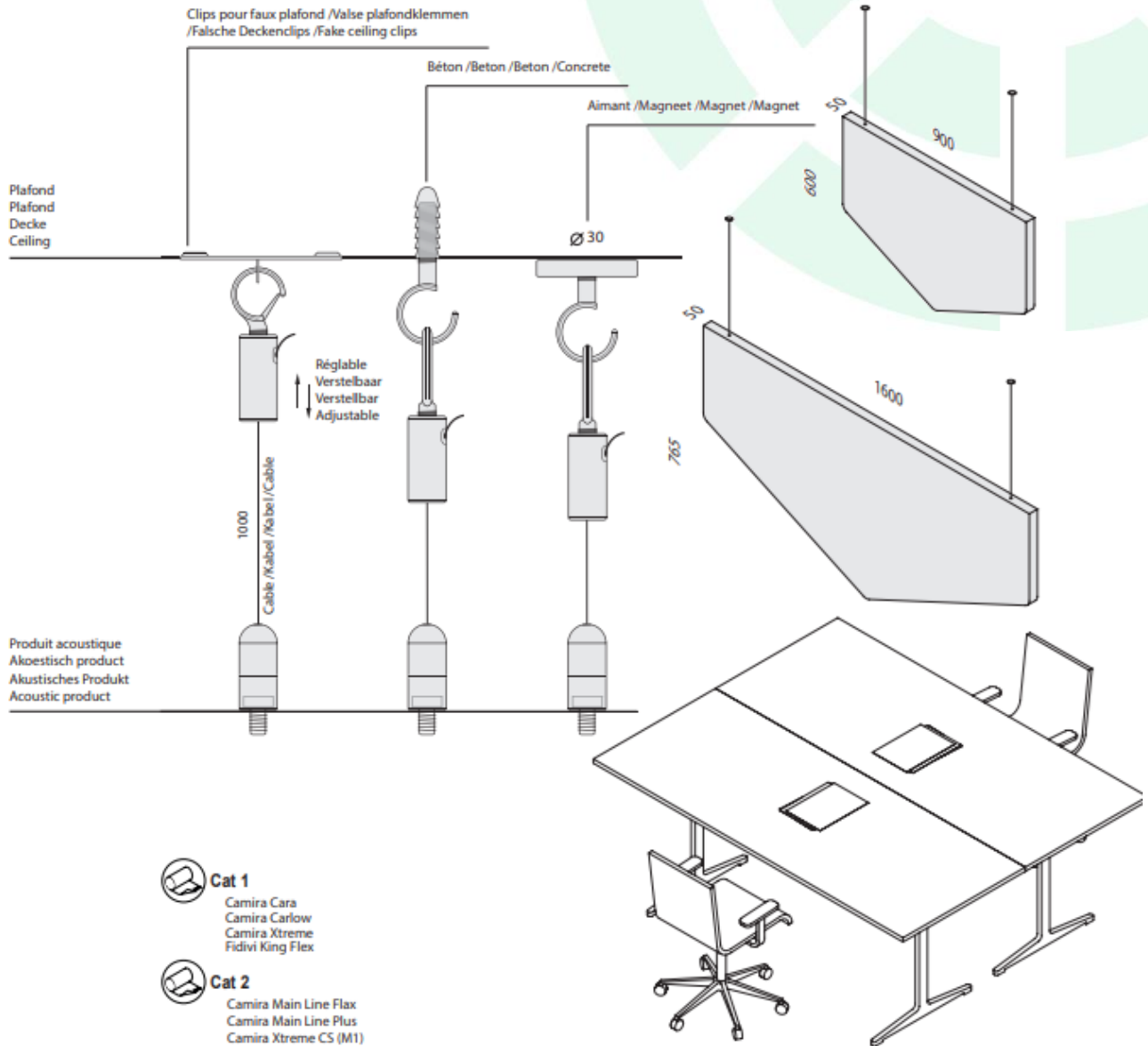

PLANK
600 mm
1200 mm
6 kg
8 weeks

SIGNS DOWN – DESIGN BY ALAIN BERTEAU

- 🌀 **Materiaal:** Kern van akoestisch schuimstof
- 🌀 **Bevestiging:** Kabels
- 🌀 **Absorptie:** $\alpha_w = 1.00$ / Absorptieklasse = A



- 
Cat 1
 Camira Cara
 Camira Carlow
 Camira Xtreme
 Fidivi King Flex
- 
Cat 2
 Camira Main Line Flax
 Camira Main Line Plus
 Camira Xtreme CS (M1)
- 
Cat 3
 Camira Blazer
 Camira Blazer Lite
 Camira Synergy
 Camira Silk
- 
Cat 4
 Kvadrat Canvas
 Kvadrat Divina Melange 2
 Kvadrat Remix 2
 Kvadrat Revive 2
 Kvadrat San
 Kvadrat Steel Cut Trio 3
 Gabriel Step

SIGNS DOWN



 600-765 mm

 900-1600 mm

 1 > 3

 7 weeks

SIGNS WALL – DESIGN BY ALAIN BERTEAU

- 
Materiaal: Kern van akoestisch schuimstof, geperforeerd paneel
- 
Bevestiging: Velcro
- 
Absorptie: $\alpha_w = 0.45$ (MH) / Absorptieklasse = D

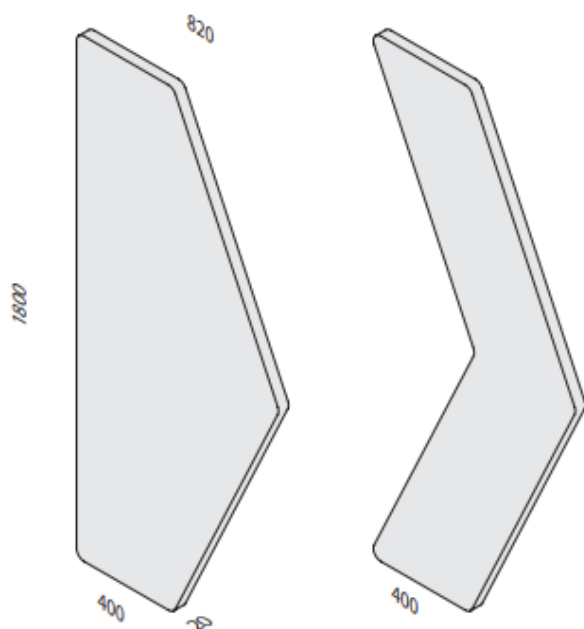

START

NEXT



Cat 1

Camira Cara
Camira Carlow
Camira Xtreme
Fidivi King Flex



Cat 2

Camira Main Line Flax
Camira Main Line Plus
Camira Xtreme CS (M1)



Cat 3

Camira Blazer
Camira Blazer Lite
Camira Synergy
Camira Silk



Cat 4

Kvadrat Canvas
Kvadrat Divina Melange 2
Kvadrat Remix 2
Kvadrat Revive 2
Kvadrat San
Kvadrat Steel Cut Trio 3
Gabriel Step

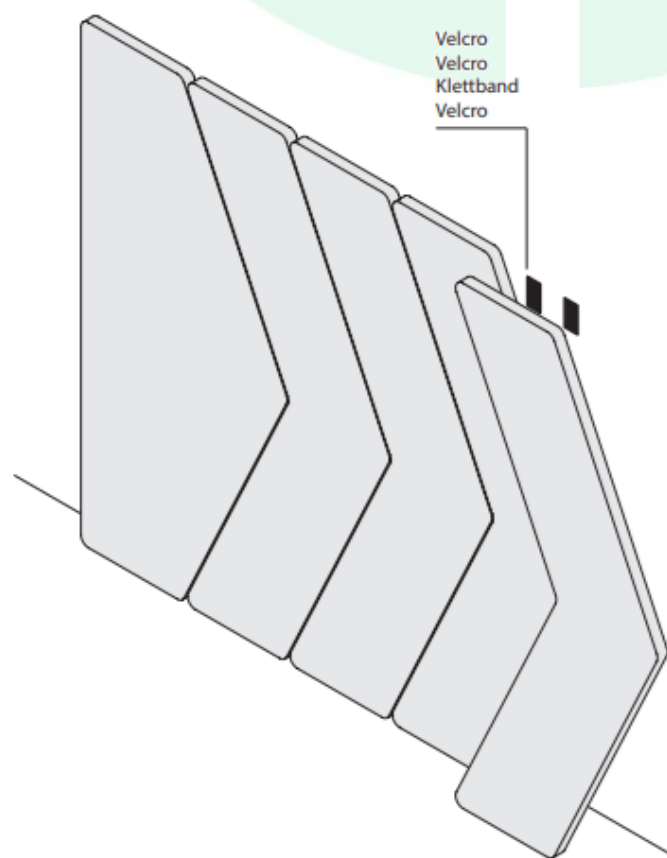

Velcro
Velcro
Klettband
Velcro

SIGNS WALL



1800 mm



400-820 mm



2 > 4



7 weeks

SIGNS DESK – DESIGN BY ALAIN BERTEAU

- 🌀 **Materiaal:** Kern van akoestisch schuimstof, geperforeerd paneel
- 🌀 **Bevestiging:** Klemmen
- 🌀 **Absorptie:** $\alpha_w = 1.00$ / Absorptieklasse = A

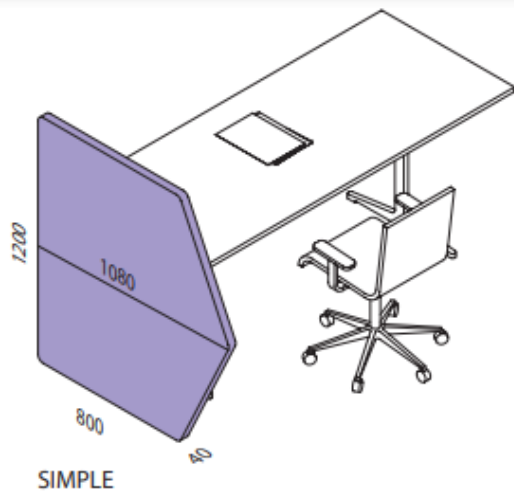

SIMPLE

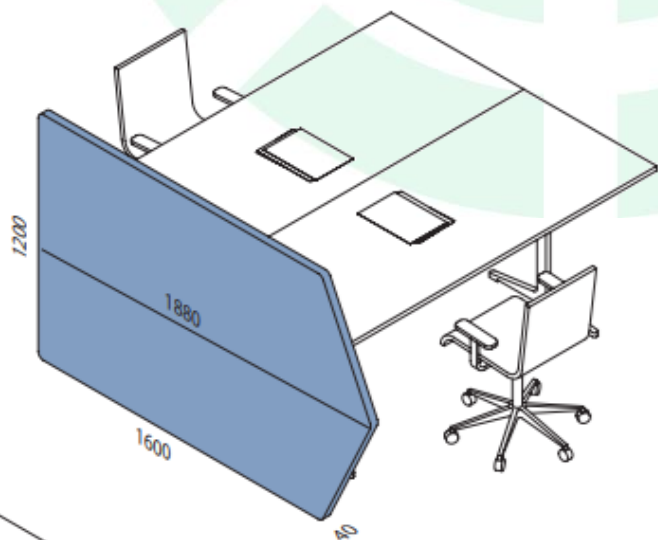

DOUBLE

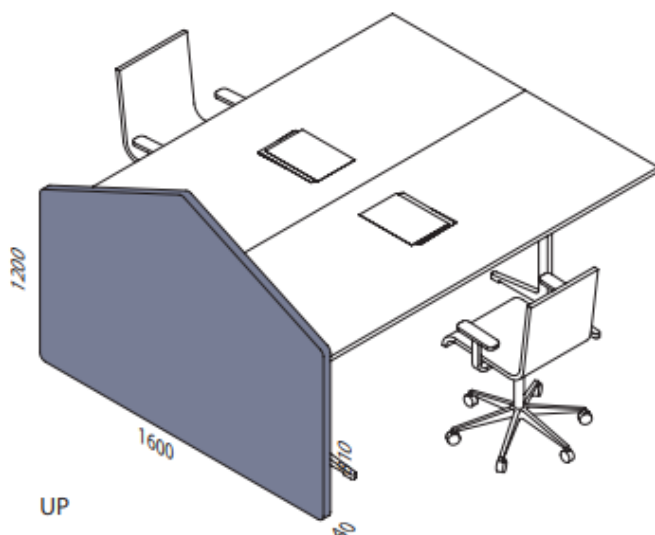

UP

 **Cat 1**
 Camira Cara
 Camira Carlow
 Camira Xtreme
 Fidivi King Flex

 **Cat 2**
 Camira Main Line Flax
 Camira Main Line Plus
 Camira Xtreme CS (M1)

 **Cat 3**
 Camira Blazer
 Camira Blazer Lite
 Camira Synergy
 Camira Silk

 **Cat 4**
 Kvadrat Canvas
 Kvadrat Divina Melange 2
 Kvadrat Remix 2
 Kvadrat Revive 2
 Kvadrat San
 Kvadrat Steel Cut Trio 3
 Gabriel Step

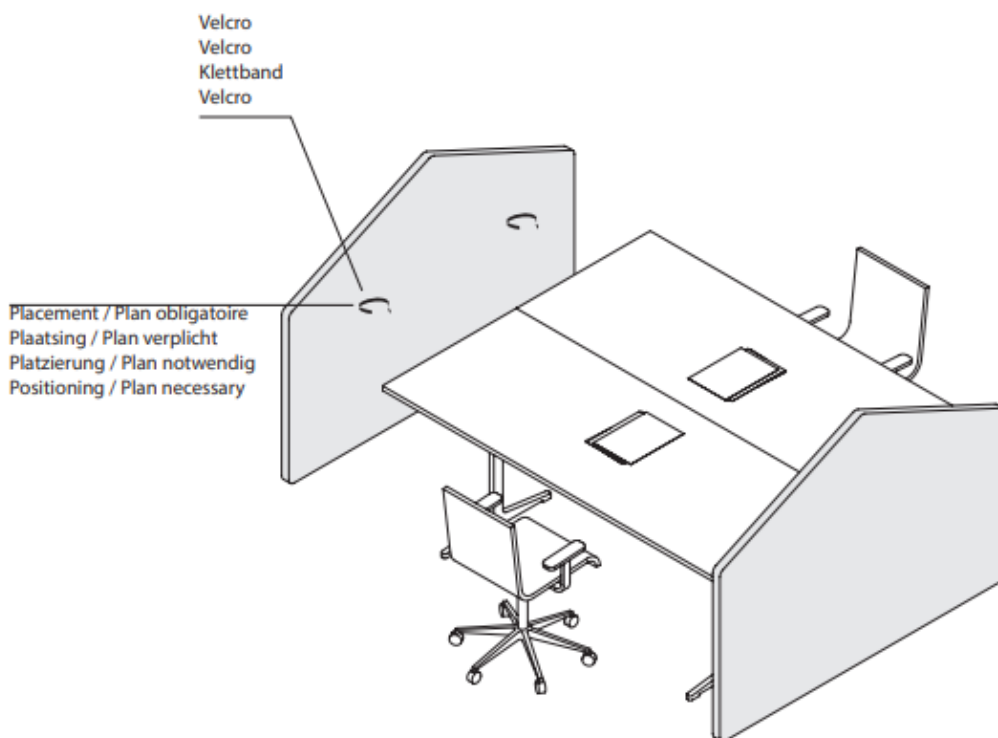
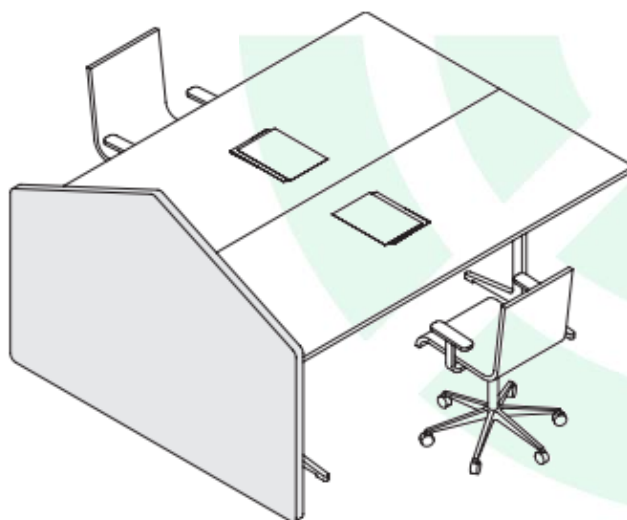

SIGNS SIMPLE
SIGNS DOUBLE
SIGNS UP

↓
1200 mm

↔
1080 mm
1880 mm
1600 mm

kg
14
26
23

🕒
7 weeks
7 weeks
7 weeks

PLAFONDBEVESTIGING

