

SURFACES

Des panneaux muraux, des écrans & des baffles design

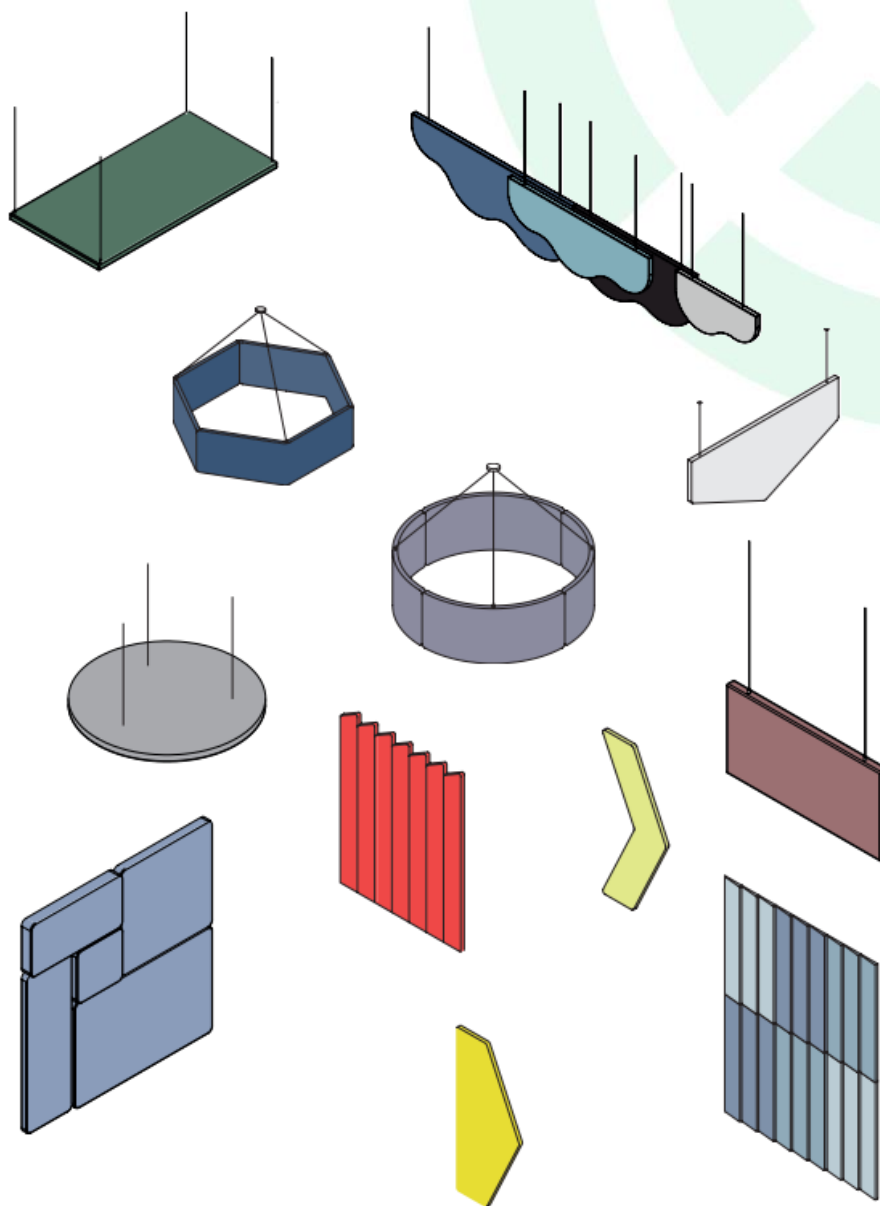

Cette solution DESIGN acoustique, spécialement conçue par les designers Julien Renault et Alain Berteau, offre les architectes (intérieur) une liberté créative et répond à la fois aux exigences esthétiques et acoustiques de tous les intérieurs.





AVANTAGES

- ✓ **Choix de multiples formes**
- ✓ **Choix de 200+ couleurs**
- ✓ **Flexible**
- ✓ **Facile à installer**
- ✓ **Design épuré**

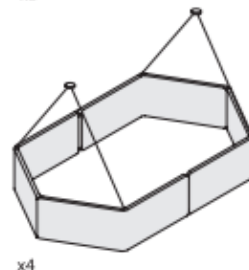
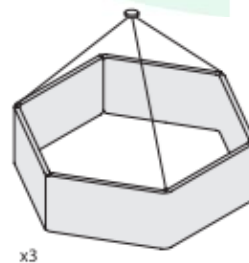
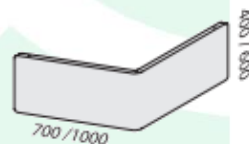
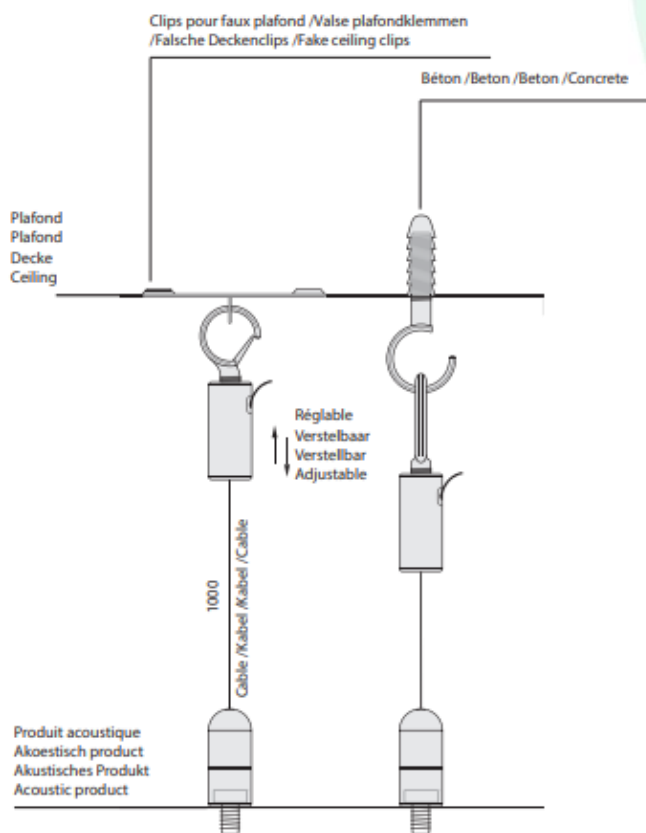
FOLD – DESIGN BY JULIEN RENAULT

 **Matériau:** Mousse acoustique



-  **Cat 1**
Camira Cara
Camira Carlow
Camira Xtreme
Fidivi King Flex
-  **Cat 2**
Camira Main Line Flax
Camira Main Line Plus
Camira Xtreme CS (M1)
-  **Cat 3**
Camira Blazer
Camira Blazer Lite
Camira Synergy
Camira Silk
-  **Cat 4**
Kvadrat Canvas
Kvadrat Divina Melange 2
Kvadrat Remix 2
Kvadrat Revive 2
Kvadrat San
Kvadrat Steel Cut Trio 3
Gabriel Step

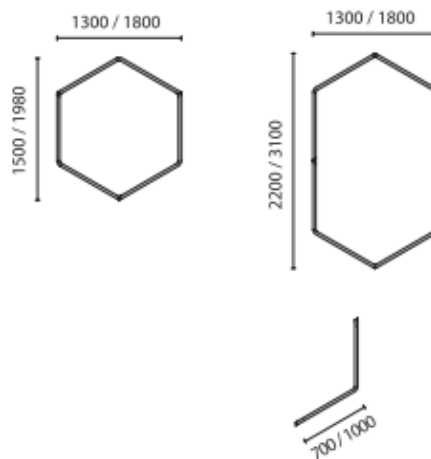
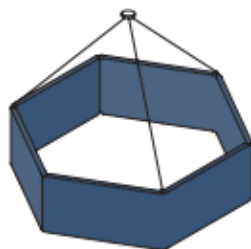

FOLD

 400-600 mm

 1300-1800 mm





 kg
4 > 7

 7 weeks

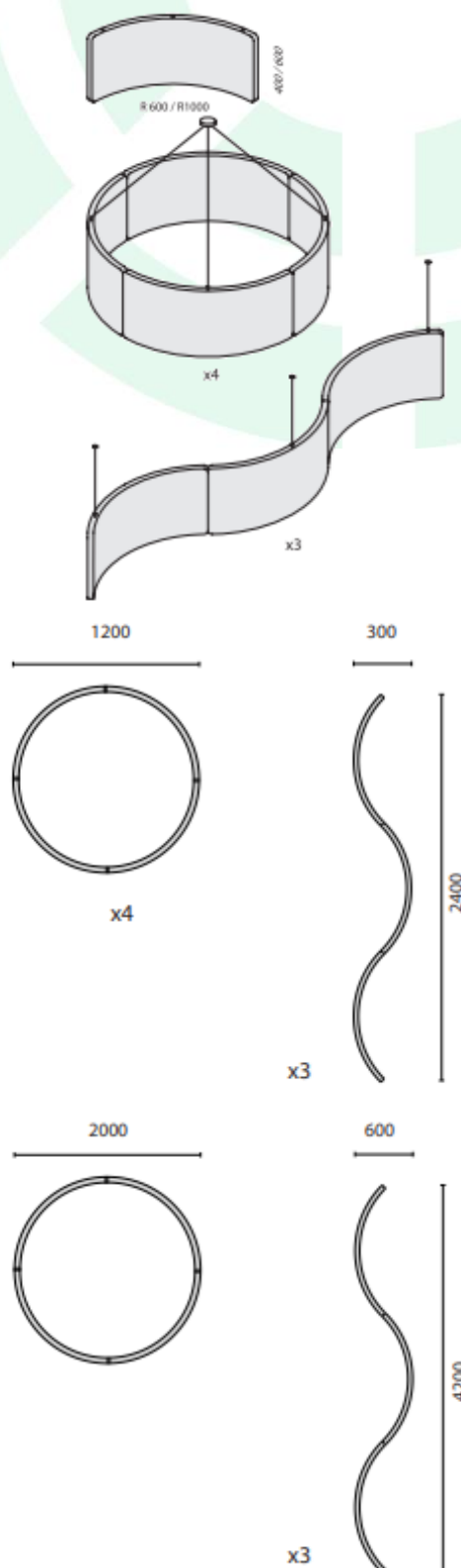
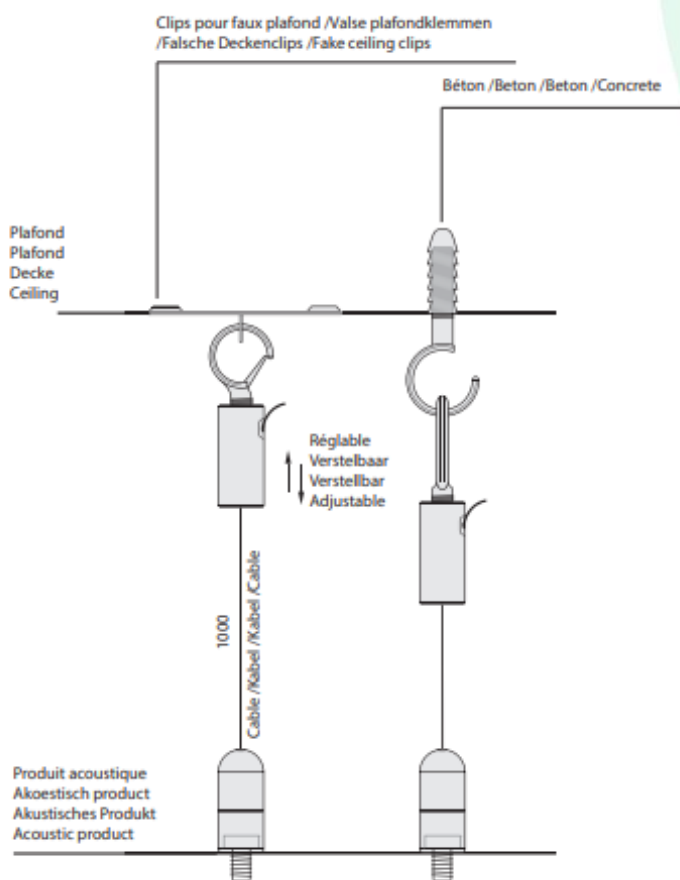
SLICE – DESIGN BY ALAIN BERTEAU

 **Matériau:** Mousse acoustique







-  **Cat 1**
Camira Cara
Camira Carlow
Camira Xtreme
Fidivi King Flex
-  **Cat 2**
Camira Main Line Flax
Camira Main Line Plus
Camira Xtreme CS (M1)
-  **Cat 3**
Camira Blazer
Camira Blazer Lite
Camira Synergy
Camira Silk
-  **Cat 4**
Kvadrat Canvas
Kvadrat Divina Melange 2
Kvadrat Remix 2
Kvadrat Revive 2
Kvadrat San
Kvadrat Steel Cut Trio 3
Gabriel Step

SLICE  400-600 mm  600-1000 mm  4 > 7  7 weeks

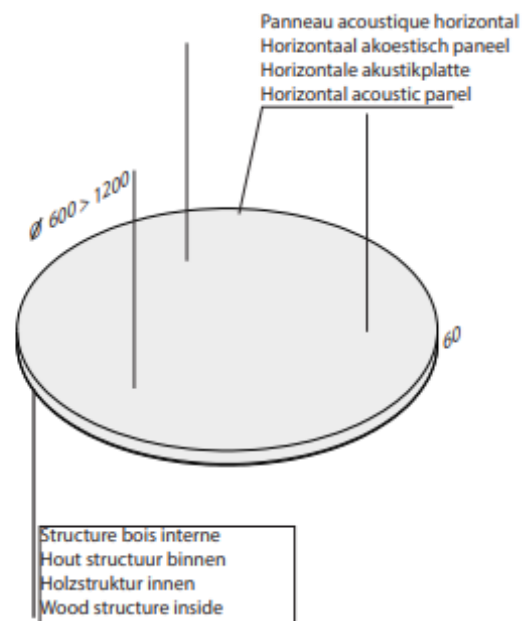
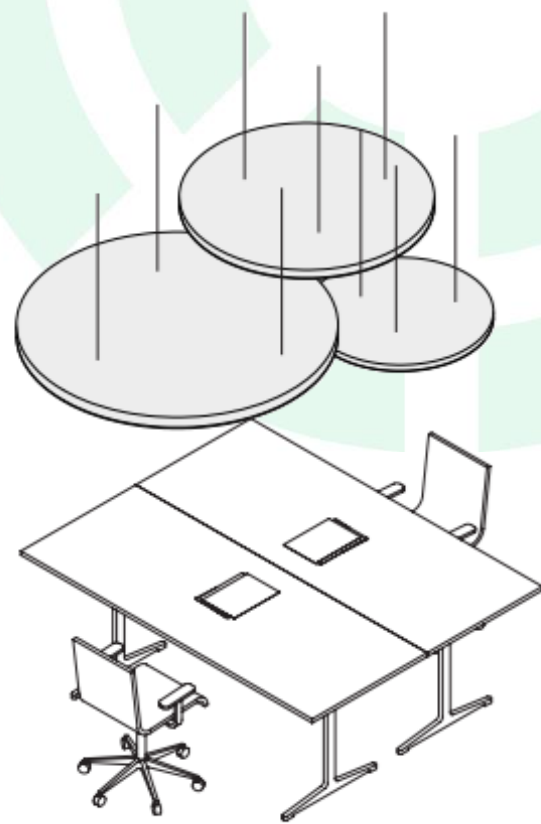
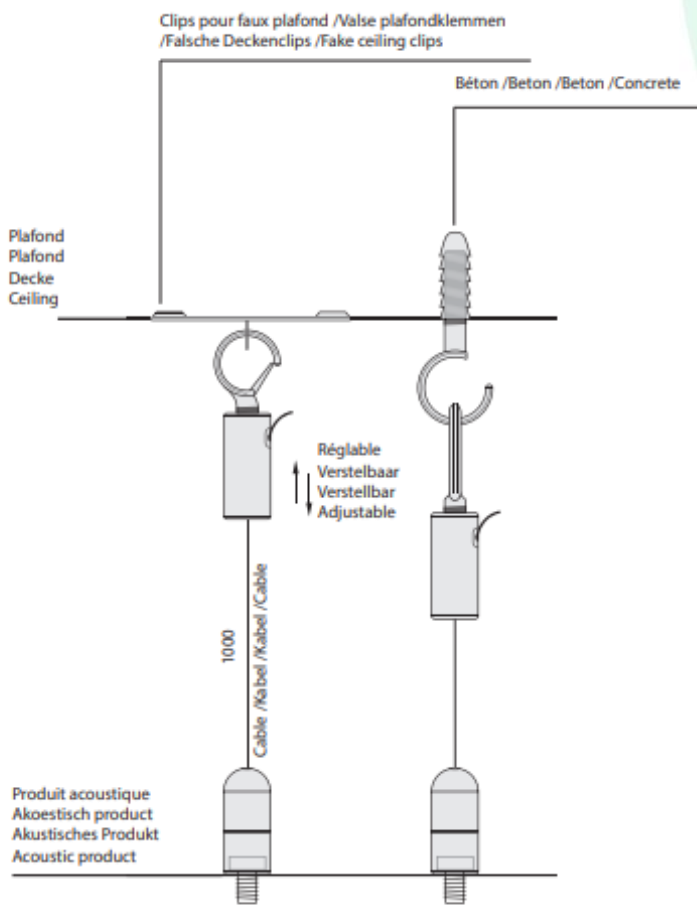
CIRCLE

 **Matériau: Mousse acoustique**



-  **Cat 1**
Camira Cara
Camira Carlow
Camira Xtreme
Fidivi King Flex
-  **Cat 2**
Camira Main Line Flax
Camira Main Line Plus
Camira Xtreme CS (M1)
-  **Cat 3**
Camira Blazer
Camira Blazer Lite
Camira Synergy
Camira Silk
-  **Cat 4**
Kvadrat Canvas
Kvadrat Divina Melange 2
Kvadrat Remix 2
Kvadrat Revive 2
Kvadrat San
Kvadrat Steel Cut Trio 3
Gabriel Step

CIRCLE



60 mm

400-600-800-1000-1200 mm

2 > 5

7 weeks

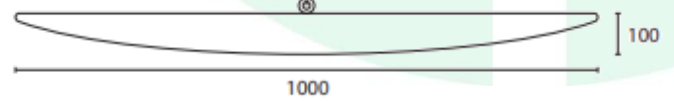
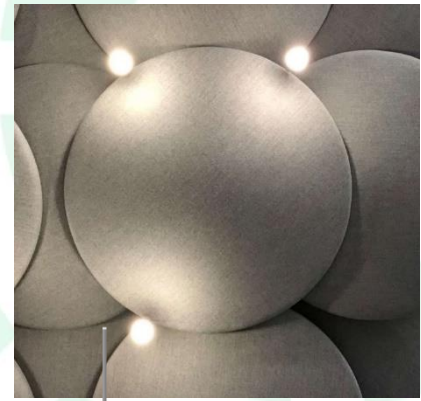
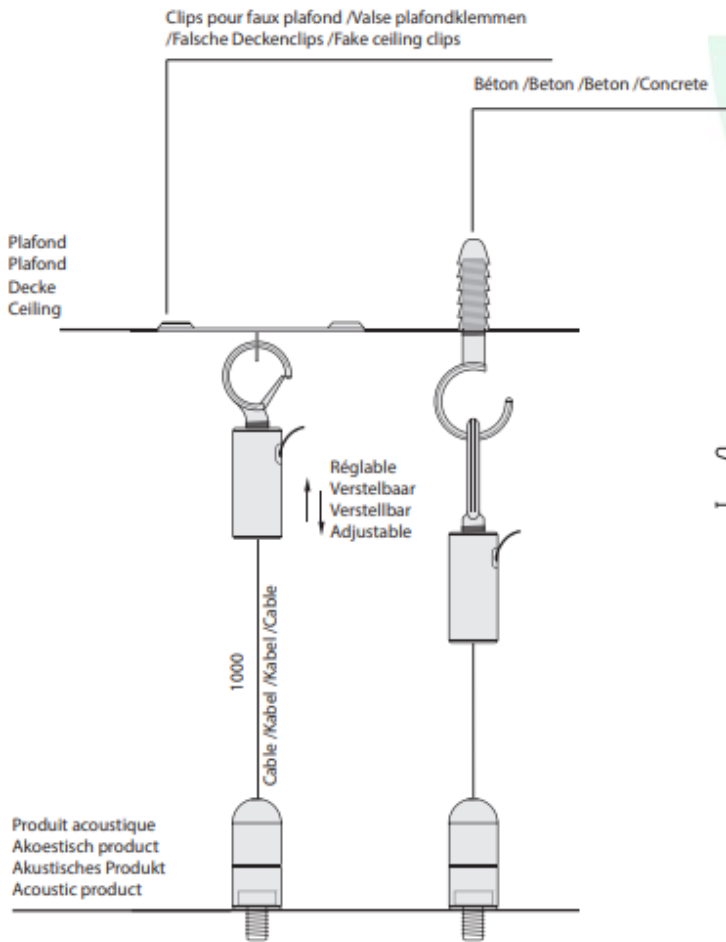
MUSHROOMS



Cat 3
 Camira Blazer
 Camira Blazer Lite
 Camira Synergy



100 mm



1000 mm







6

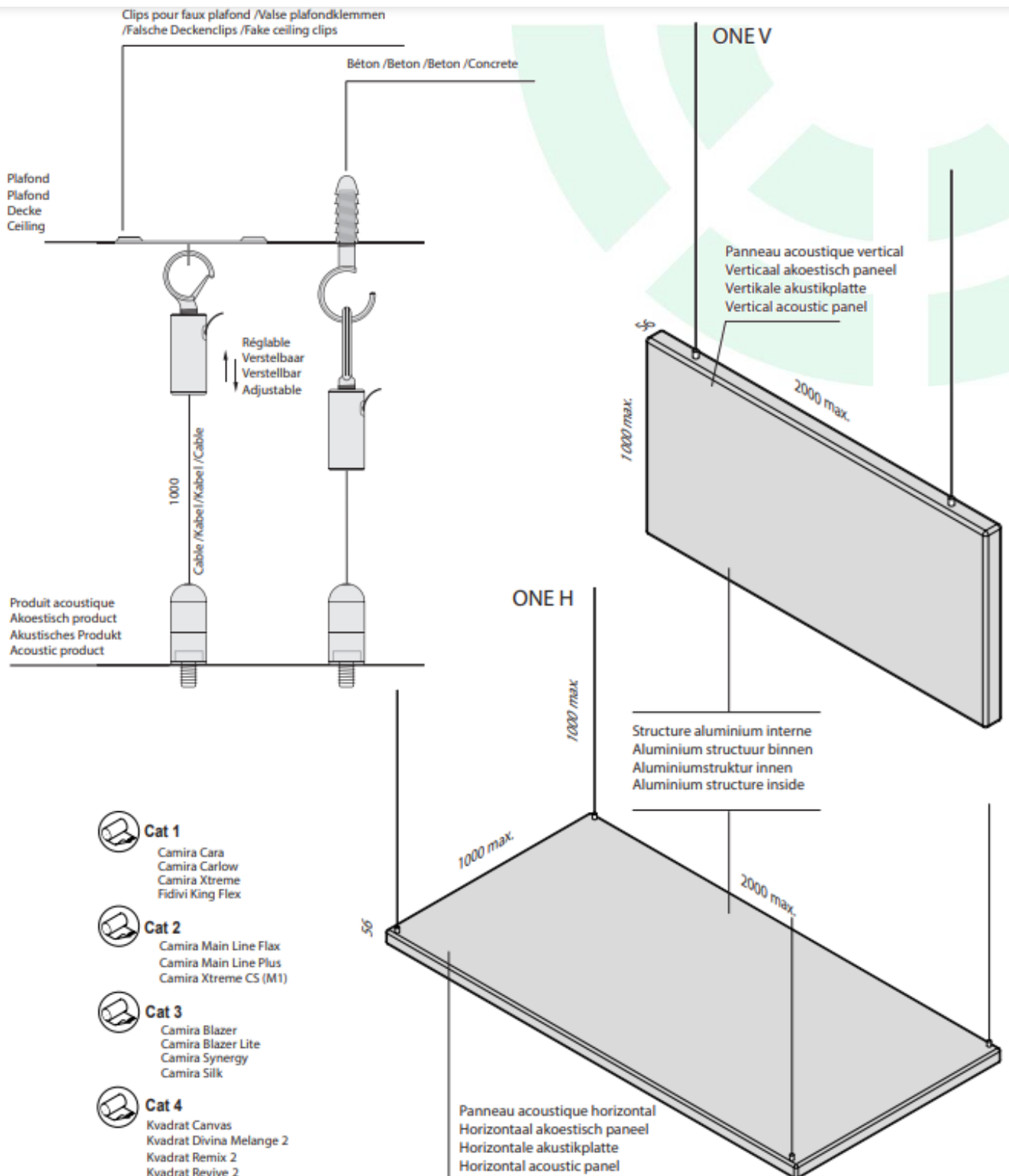

8 weeks

RECTANGLE – ONE V / ONE H



-  **Cat 1**
Camira Cara
Camira Carlow
Camira Xtreme
Fidivi King Flex
-  **Cat 2**
Camira Main Line Flax
Camira Main Line Plus
Camira Xtreme CS (M1)
-  **Cat 3**
Camira Blazer
Camira Blazer Lite
Camira Synergy
Camira Silk
-  **Cat 4**
Kvadrat Canvas
Kvadrat Divina Melange 2
Kvadrat Remix 2
Kvadrat Revive 2
Kvadrat San
Kvadrat Steel Cut Trio 3
Gabriel Step

RECTANGLE ONE H - ONE V

 600-800-1000 mm

 1000-1200-1400-1600-1800-2000 mm

 3 > 8

 8 weeks

RECTANGLE – THREE

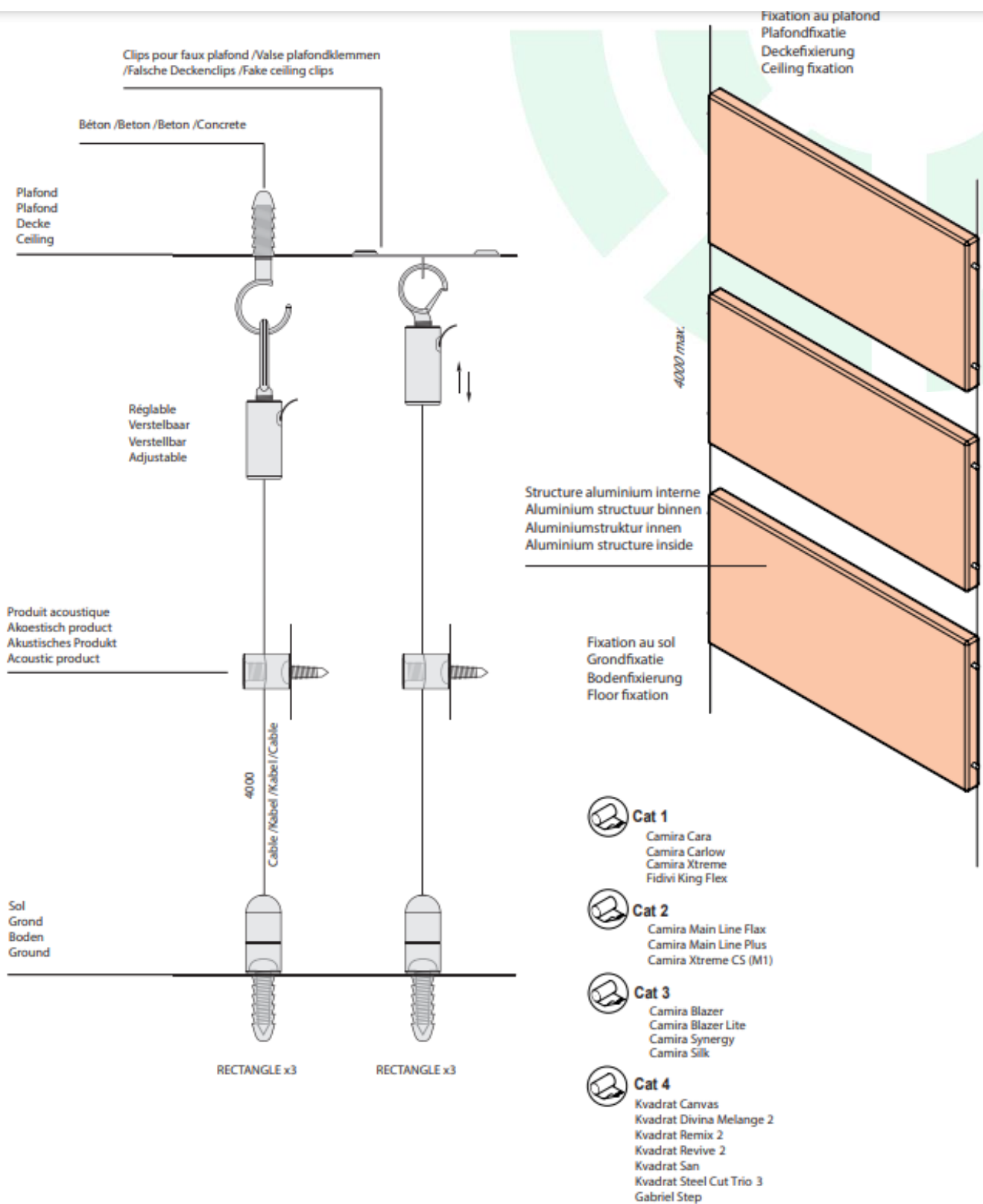

RECTANGLE THREE

400-600-800 mm

1000-1200-1400-1600-1800-2000 mm

12 > 18

8 weeks

PAVING 3D – DESIGN BY ALAIN BERTEAU / JULIEN RENAULT

- 🌀 **Matériau:** Mousse acoustique, panneau perforé
- 🌀 **Fixation:** Velcro
- 🌀 **Absorption:** $\alpha_w = 0.45$ (MH) / Classe d'absorption = D

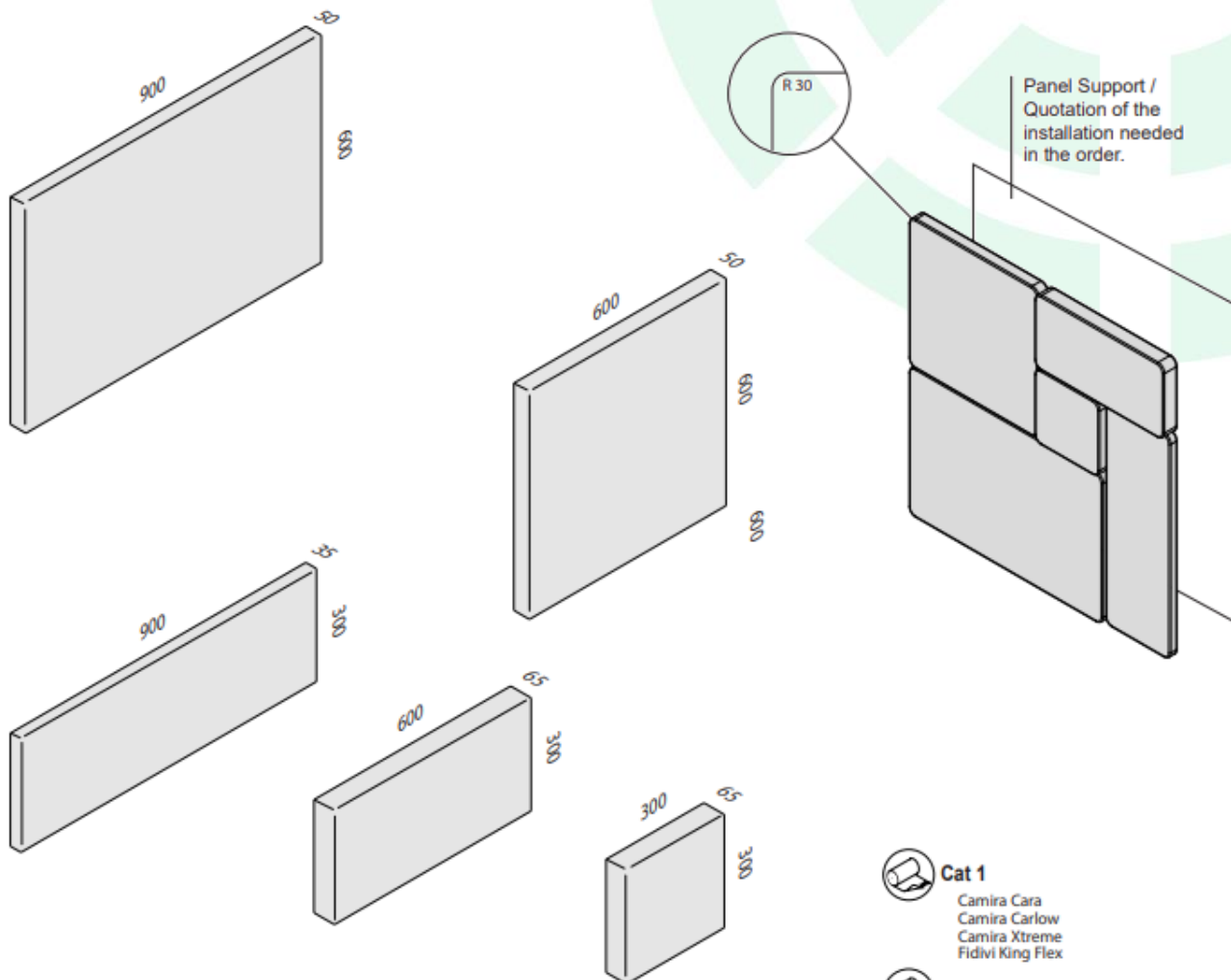

ONE FABRIC REFERENCE BY MODULE

1 MODULE = 1.44 m²

ONLY AVAILABLE AS 1.44 m² / 5 ELEMENTS



Cat 1

Camira Cara
Camira Carlow
Camira Xtreme
Fidivi King Flex



Cat 2

Camira Main Line Flax
Camira Main Line Plus
Camira Xtreme CS (M1)



Cat 3

Camira Blazer
Camira Blazer Lite
Camira Synergy
Camira Silk



Cat 4

Kvadrat Canvas
Kvadrat Divina Melange 2
Kvadrat Remix 2
Kvadrat Revive 2
Kvadrat San
Kvadrat Steel Cut Trio 3
Gabriel Step

PAVING 3D



1200 mm



1200 mm



6



8 weeks

FENCE – DESIGN BY JULIEN RENAULT

- 🌀 **Matériau:** Mousse acoustique, panneau perforé
- 🌀 **Fixation:** Velcro
- 🌀 **Absorption:** $\alpha_w = 0.45$ (MH) / Classe d'absorption = D

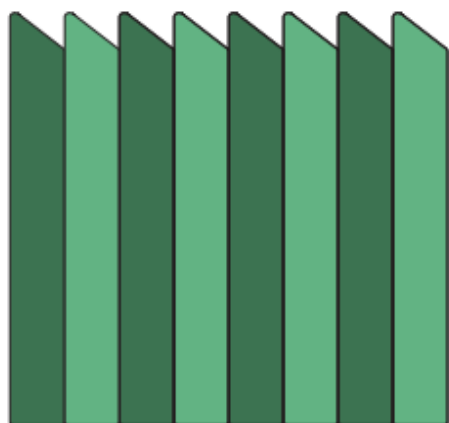

20

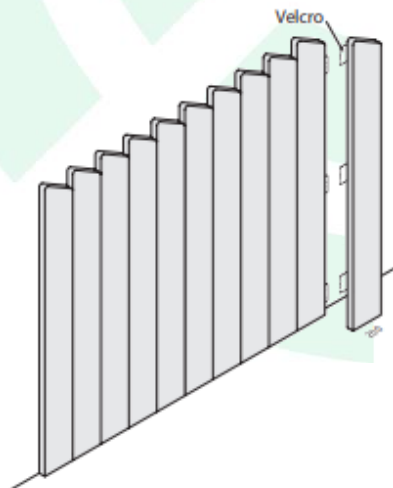

Cat 1

Camira Cara
Camira Carlow
Camira Xtreme
Fidivi King Flex



Cat 2

Camira Main Line Flax
Camira Main Line Plus
Camira Xtreme CS (M1)



Cat 3

Camira Blazer
Camira Blazer Lite
Camira Synergy
Camira Silk



Cat 4

Kvadrat Canvas
Kvadrat Divina Melange 2
Kvadrat Remix 2
Kvadrat Revive 2
Kvadrat San
Kvadrat Steel Cut Trio 3
Gabriel Step



FENCE



1200 mm



1200 mm



3





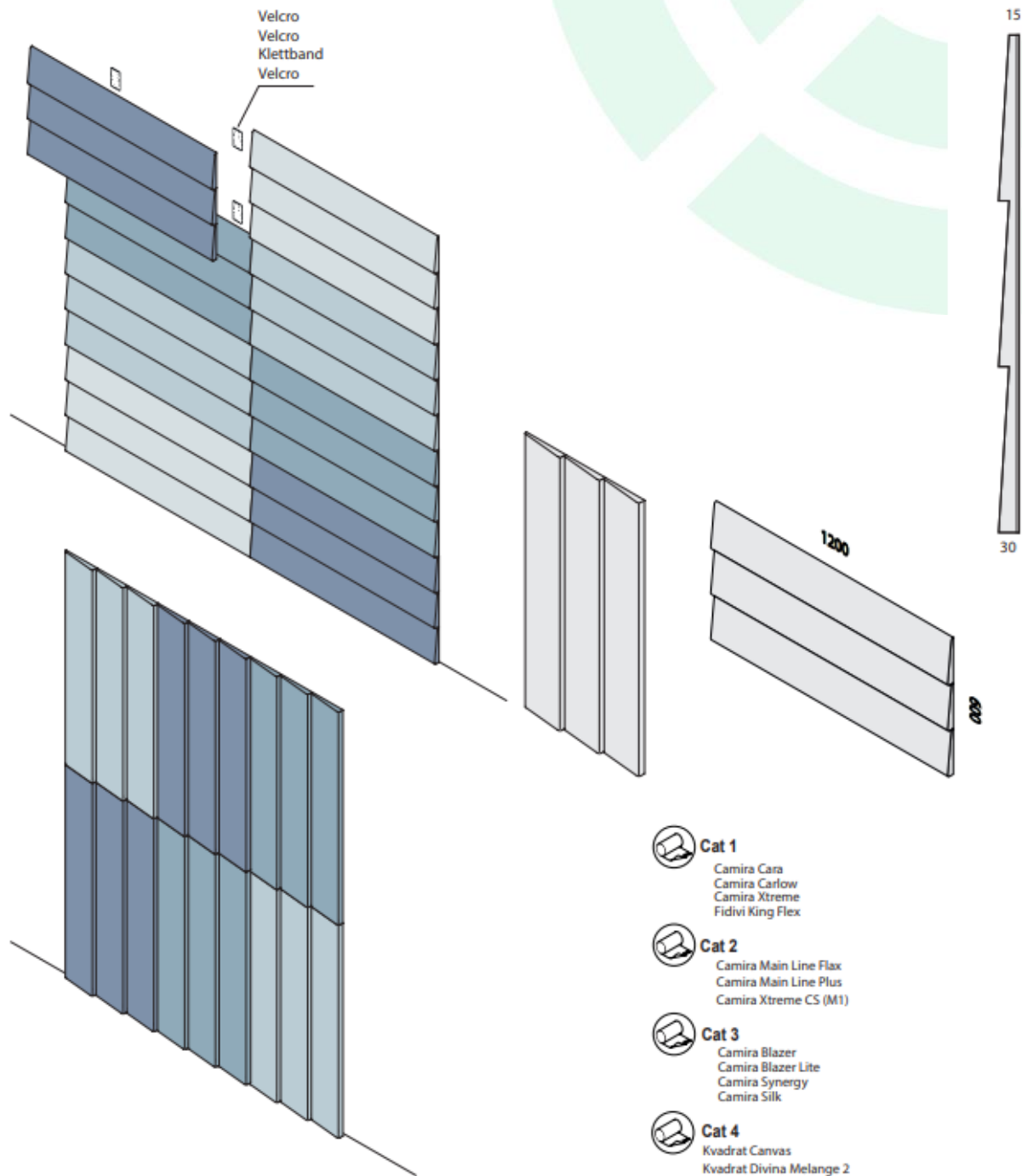

8 weeks

PLANK – JULIEN RENAULT

- 🌀 **Matériau:** Mousse acoustique, panneau perforé
- 🌀 **Fixation:** Velcro
- 🌀 **Absorption:** $\alpha_w = 0.60$ (MH) / Classe d'absorption = C



-  **Cat 1**
Camira Cara
Camira Carlow
Camira Xtreme
Fidivi King Flex
-  **Cat 2**
Camira Main Line Flax
Camira Main Line Plus
Camira Xtreme CS (M1)
-  **Cat 3**
Camira Blazer
Camira Blazer Lite
Camira Synergy
Camira Silk
-  **Cat 4**
Kvadrat Canvas
Kvadrat Divina Melange 2
Kvadrat Remix 2
Kvadrat Revive 2
Kvadrat San
Kvadrat Steel Cut Trio 3
Gabriel Step

PLANK

 600 mm

 1200 mm





 6

 8 weeks

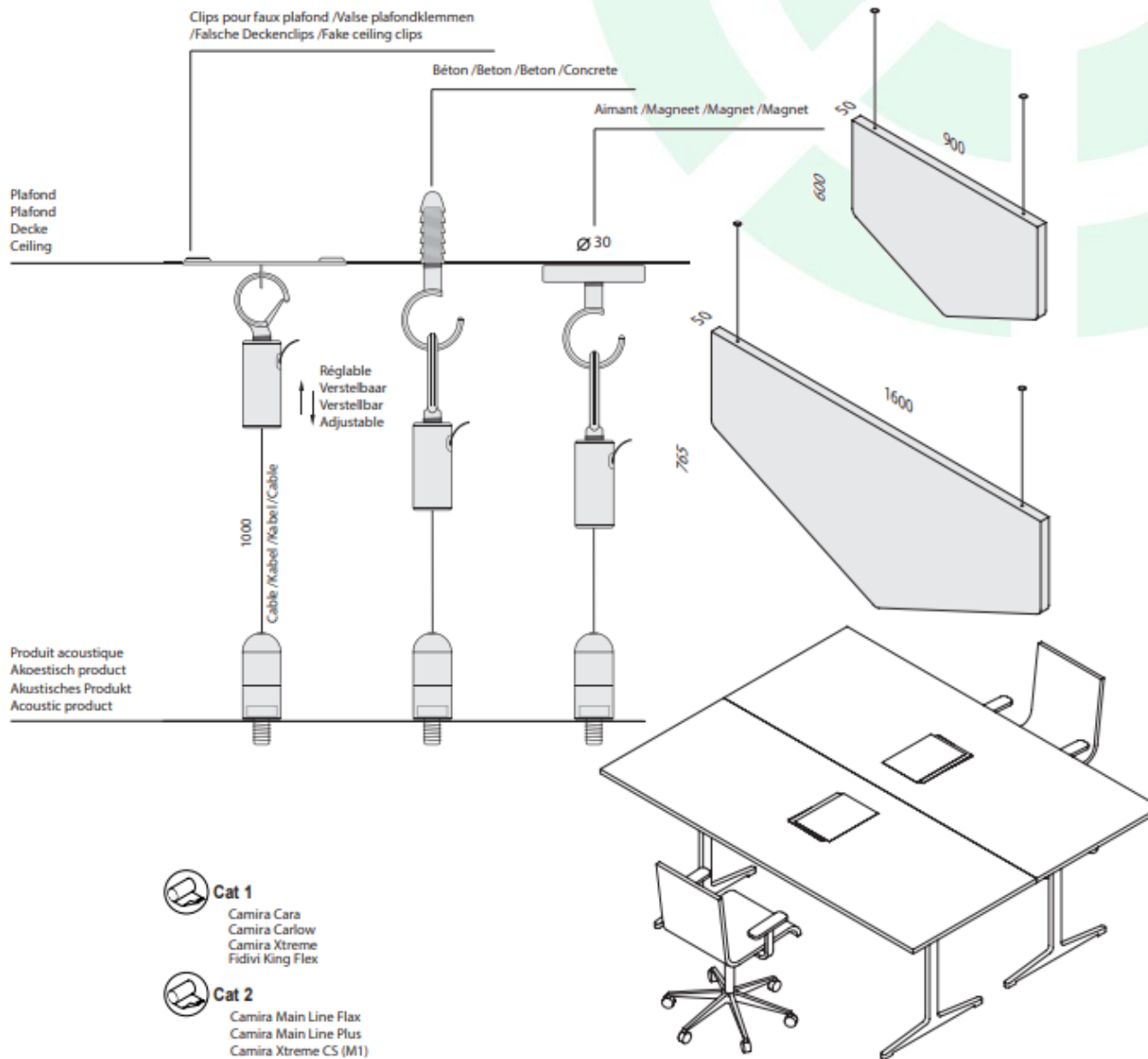
SIGNS DOWN – DESIGN BY ALAIN BERTEAU

- 🌀 **Matériau:** Mousse acoustique
- 🌀 **Fixation:** Des cables
- 🌀 **Absorption:** $\alpha_w = 1.00$ / Classe d'absorption = A



-  **Cat 1**
Camira Cara
Camira Carlow
Camira Xtreme
Fidivi King Flex
-  **Cat 2**
Camira Main Line Flax
Camira Main Line Plus
Camira Xtreme CS (M1)
-  **Cat 3**
Camira Blazer
Camira Blazer Lite
Camira Synergy
Camira Silk
-  **Cat 4**
Kvadrat Canvas
Kvadrat Divina Melange 2
Kvadrat Remix 2
Kvadrat Revive 2
Kvadrat San
Kvadrat Steel Cut Trio 3
Gabriel Step

SIGNS DOWN

 600-765 mm

 900-1600 mm

 1 > 3

 7 weeks

SIGNS WALL – DESIGN BY ALAIN BERTEAU

- 🌀 **Matériau:** Mousse acoustique, panneau perforé
- 🌀 **Fixation:** Velcro
- 🌀 **Absorption:** $\alpha_w = 0.45$ (MH) / Classe d'absorption = D

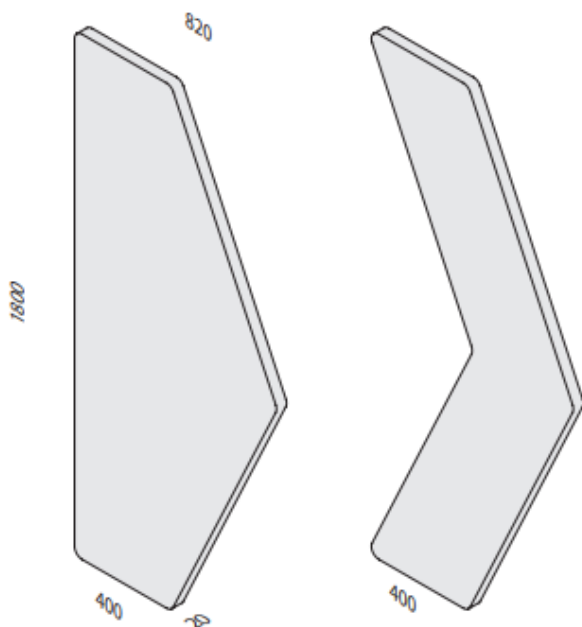

START

NEXT



Cat 1

Camira Cara
Camira Carlow
Camira Xtreme
Fidivi King Flex



Cat 2

Camira Main Line Flax
Camira Main Line Plus
Camira Xtreme CS (M1)



Cat 3

Camira Blazer
Camira Blazer Lite
Camira Synergy
Camira Silk



Cat 4

Kvadrat Canvas
Kvadrat Divina Melange 2
Kvadrat Remix 2
Kvadrat Revive 2
Kvadrat San
Kvadrat Steel Cut Trio 3
Gabriel Step

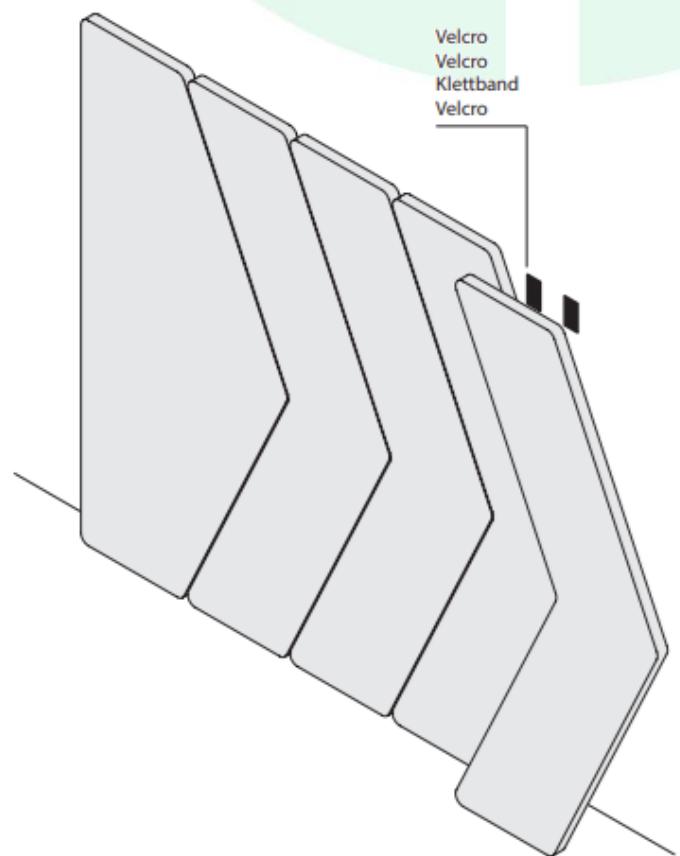

SIGNS WALL



1800 mm



400-820 mm



2 > 4



7 weeks

SIGNS DESK – DESGIN BY ALAIN BERTEAU

- 🌀 **Matériau:** Mousse acoustique, panneau perforé
- 🌀 **Fixation:** Des clips
- 🌀 **Absorption:** $\alpha_w = 1.00$ / Classe d'absorption = A

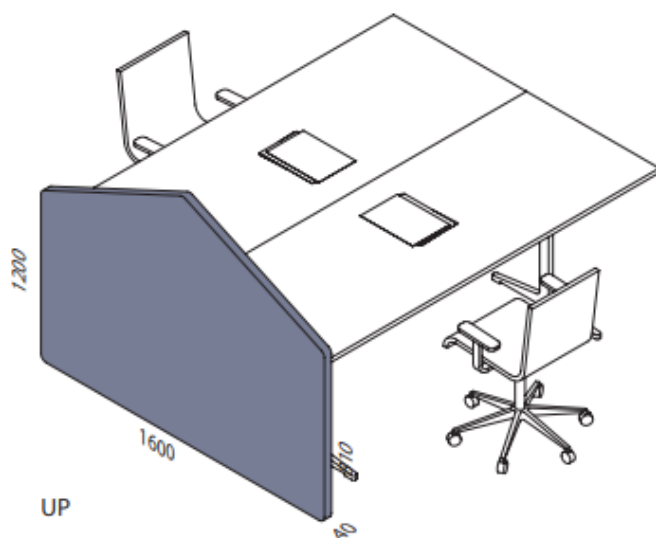
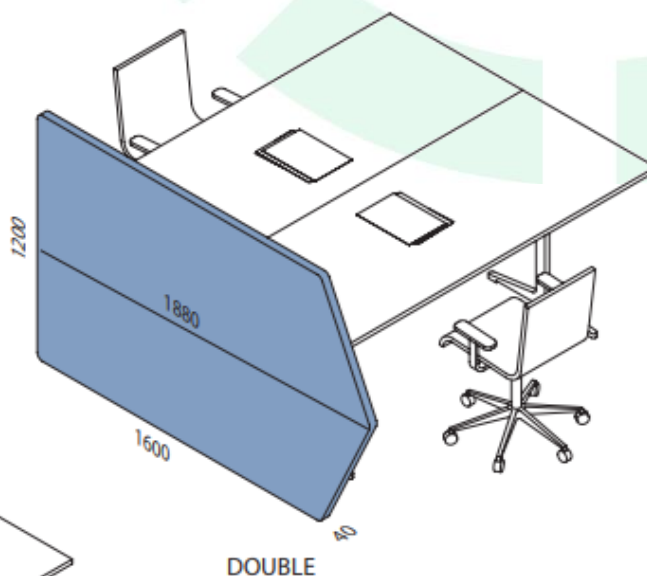
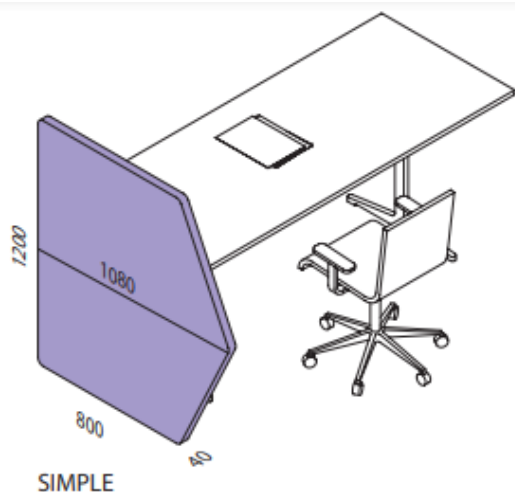

Cat 1

Camira Cara
Camira Carlow
Camira Xtreme
Fidivi King Flex



Cat 2

Camira Main Line Flax
Camira Main Line Plus
Camira Xtreme CS (M1)



Cat 3

Camira Blazer
Camira Blazer Lite
Camira Synergy
Camira Silk



Cat 4

Kvadrat Canvas
Kvadrat Divina Melange 2
Kvadrat Remix 2
Kvadrat Revive 2
Kvadrat San
Kvadrat Steel Cut Trio 3
Gabriel Step

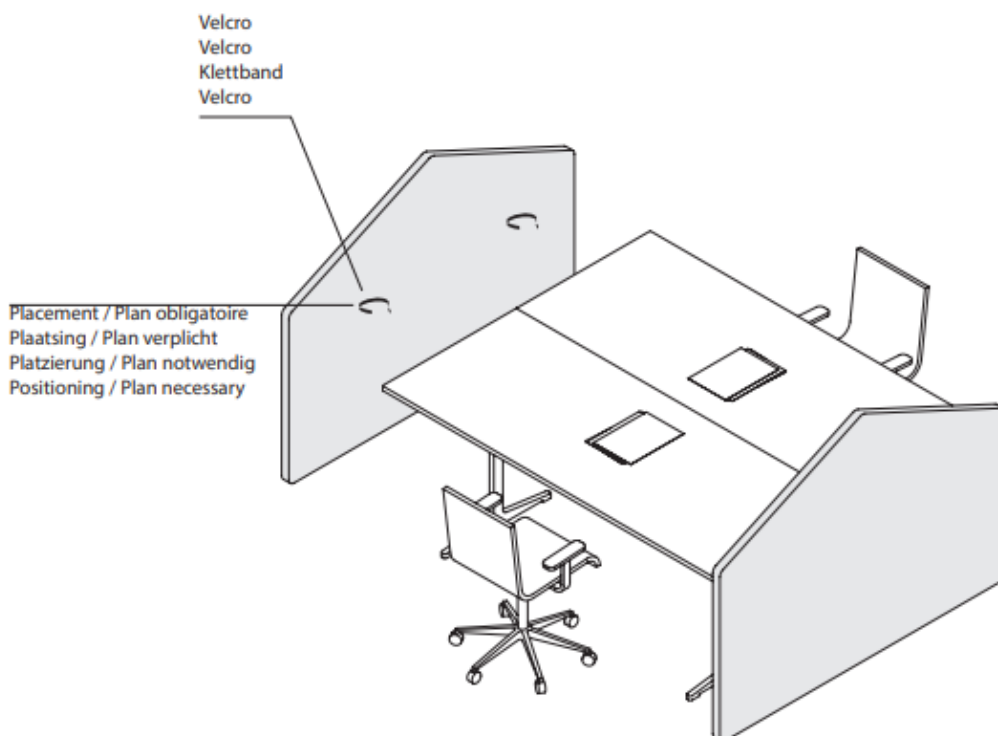
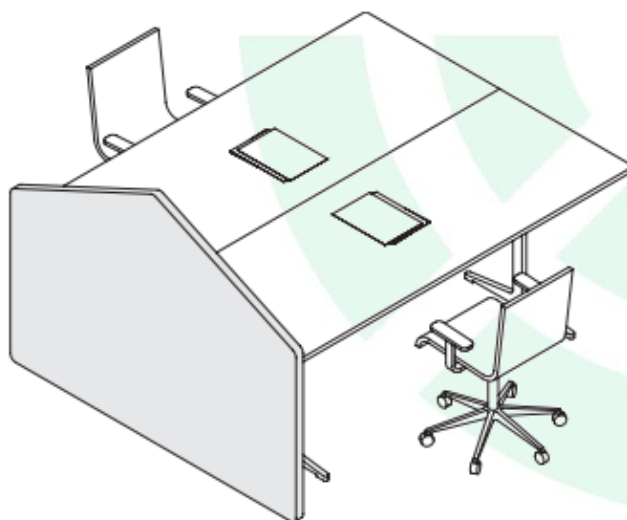

SIGNS SIMPLE
SIGNS DOUBLE
SIGNS UP

↓
1200 mm
1200 mm
1200 mm

↔
1080 mm
1880 mm
1600 mm

kg
14
26
23

🕒
7 weeks
7 weeks
7 weeks

FIXATION AU PLAFOND

